



Operation & Installation Manual

SDE **1LH** **3LH** **1DXS** **DX**
SERIES SERIES SERIES SERIES SERIES

VARIABLE FREQUENCY DRIVES

Low Harmonic | Six-Pulse | Phase Converting | Three-Phase



**INTUITIVELY
ENGINEERED**

Product Manual

Variable Frequency Drives

SDE SERIES

3R Package
Low Harmonic
IEEE 519 Compliant
Phase Converting

1LH SERIES

3R Package
Low Harmonic
IEEE 519 Compliant
Phase Converting
Voltage Doubling

3LH SERIES

3R Package
Low Harmonic
IEEE 519 Compliant
Three Phase
Voltage Doubling

DX SERIES

Six-Pulse
Three Phase
3R Package

ENTERPRISE

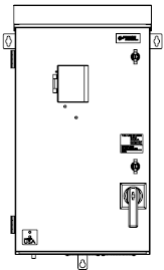

5 HP to 50 HP

SIGNATURE

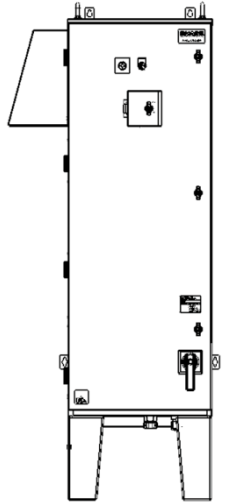

20 HP to 200 HP

PERFORMANCE

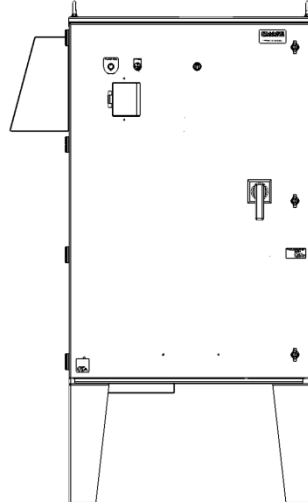

20 HP to 450 HP



CONTACT INFORMATION

Address: 222 Disk Drive, Rapid City, SD 57701

Phone: 605-343-7934

Fax: 605-343-7943

Toll Free: 866-250-7934

www.phasetechnologies.com



#3187280



SCAN TO DOWNLOAD MANUAL
ELECTRONICALLY

2021 © Copyright. V3.0 All rights reserved. All contents are property of Phase Technologies, LLC.

No portion of this publication or its contents may be duplicated by any means, electronic or otherwise, without the express written consent of Phase Technologies, LLC.

SAFETY MESSAGES AND WARNINGS

To ensure safe and reliable operation of Phase Technologies variable frequency drives, it is important to carefully read this manual and to read and observe all warning labels attached to the drive before installing the equipment. Please follow all instructions exactly and always keep this manual with the equipment for quick and easy reference.

Definitions of Warning Signs and Symbols

 **CAUTION:** Indicates a potentially hazardous situation that could result in injury or damage to the product.

 **WARNING:** Indicates a potentially hazardous situation that could result in serious injury or death.

 **HIGH VOLTAGE:** Indicates high voltage. The voltage associated with the procedures or operations referenced could result in serious injury or death. Use caution and follow instructions carefully.

READ THESE WARNINGS BEFORE INSTALLING OR OPERATING EQUIPMENT!

 **WARNING:** Risk of electric shock. De-energize the unit by disconnecting all incoming sources of power, then wait 10 minutes for internal charges to dissipate before servicing the equipment.

 **HIGH VOLTAGE:** This equipment is connected to line voltages that can create a potentially hazardous situation. Electric shock could result in serious injury or death. This device should be installed only by trained, licensed and qualified personnel. Follow instructions carefully and observe all warnings.

 **WARNING:** This equipment should be installed and serviced by qualified personnel familiar with the type of equipment and experienced in working with dangerous voltages.

 **WARNING:** Installation of this equipment must comply with the National Electrical Code (NEC) and all applicable local codes. Failure to observe and comply with these codes could result in risk of electric shock, fire, or damage to the equipment.

 **CAUTION:** The **AUX1** through **AUX4** terminals are galvanically isolated, with approximately 5V potential between them. DO NOT apply a voltage to the terminals. Use dry contacts only.

 **CAUTION:** Circuit breakers or fuses, proper ground circuits, disconnect and other safety equipment and their proper installation are not provided by Phase Technologies, LLC, and are the responsibility of the end user.

 **CAUTION:** Long leads between the unit and the motor with an unfiltered PWM voltage can lead to dangerous voltage rise from reflected harmonics. Very long leads, such as in deep well submersible pump applications, may require the use of a sine wave filter to remove most of the harmonics from the waveform. Consult the factory or a knowledgeable source on drive filters if your application has more than 50 feet between the drive and the motor.

 **CAUTION:** Failure to maintain adequate clearance may lead to overheating of the unit and cause damage or fire.

 **WARNING:** Suitable for use in a circuit capable of delivering not more than 10 kA RMS symmetrical amperes, 480 VAC.

 **WARNING:** Wire used within the motor circuit and all field wiring terminals must be rated at least 75 °C.

 **WARNING:** Use wire size suitable for Class 1 circuits.

 **WARNING:** Input power connections should be made by a qualified electrician into a nominal 480V circuit for models with 460V input, with adequate current carrying capacity. Branch circuit protection to the drive should be provided by appropriate size fuses or circuit breaker. Circuit breaker and fuse ratings for each model are listed in **Table 4**.

 **WARNING:** These devices are equipped with integral solid-state short circuit protection. Integral solid-state short circuit protection does not provide branch circuit protection. Branch circuit protection must be provided in accordance with the National Electrical Code and any additional local codes.

 **CAUTION:** Use 600 V vinyl-sheathed wire or equivalent. The voltage drop of the leads needs to be considered in determining wire size. Voltage drop is dependent on wire length and gauge. Use copper conductors only.

 **CAUTION:** Wires fastened to the terminal blocks shall be secured by tightening the terminal screws to a torque value listed in **Table 2** and **Table 3**.

 **CAUTION:** The maximum wire gauge for the input terminals is listed in **Table 2**.

 **CAUTION:** Never allow bare wire to contact the metal surfaces.

 **CAUTION:** Never connect AC main power to the output terminals U/T1, V/T2, and W/T3.

 **WARNING:** Under certain conditions, the motor may automatically restart after a trip has stopped it. Make sure power to the drive has been disconnected before approaching or servicing the equipment. Otherwise, serious injury may occur.







-  **CAUTION:** Use caution when applying power to the main input terminals of the unit. If the drive is programmed to allow automatic restarts, the drive will initialize in AUTO mode and the motor load may start as soon as the drive is energized.
-  **CAUTION:** The AC motor load must be connected directly to the output terminals of the drive. Do not install relays or disconnect switches between the drive and the motor load.
-  **CAUTION:** Before the motor is connected to the output terminals, check all output lines for line-to-ground faults using a megger. There is a direct path through the drive circuitry for ground fault currents that can be triggered when power is applied to the input terminals, even though the output switches are not activated. These currents can cause serious damage to drive circuitry and are not covered under warranty.
-  **CAUTION:** Before touching any printed circuit board, place a hand on a bare metal surface of the unit to discharge any static electricity. Electrostatic discharge (ESD) can damage printed circuits and their components.
-  **CAUTION:** When the parameter, **ENABLE RESTARTS**, is enabled the drive will energize in AUTO mode. The motor load may automatically run as soon as the drive is energized. To stop the motor, push the STIOP/OFF key until the display indicates MANUAL or OFF, or open AUX1 or AUX2. The RUN and STOP keys only work when in MAN mode. Refer to the section on Keypad and Display for instructions on operating the keypad.
-  **CAUTION:** Operating the system in MANUAL mode on the keypad overrides remote signals from any remote controls. Operating the system in this mode may lead to dangerous pressures in closed plumbing systems.
-  **CAUTION:** Line filter capacitors should be inspected annually at a minimum. If they are degraded the electrical noise can damage equipment connected to the drive. See **Section 8** for details.

TABLE OF CONTENTS

1 INTRODUCTION	1
2 INSTALLATION	5
2.1 Mounting.....	5
2.2 General Wiring Considerations.....	6
2.3 Installing Power Cables.....	12
2.4 Control Terminals.....	13
3 KEYPAD & DISPLAY	22
3.1 Using the Keypad and Display.....	22
3.2 Keypad Main Menu Items.....	24
3.3 Change Parameter Values.....	24
3.4 Read Measured Values.....	25
3.5 Read Timers.....	26
3.6 Restart Log.....	26
3.7 Fault Log.....	27
3.8 Clear Memory.....	27
3.9 Setup Wizards.....	28
4 ADJUSTABLE PARAMETERS	31
4.1 Changing Parameter Values.....	31
4.2 Restore Default Parameter Settings.....	31
4.3 Auto Restarts.....	31
4.4 All Parameters List.....	32
4.5 Changed Parameter List.....	32
5 OPERATION	45
5.1 Commissioning the Unit.....	45

5.2 VFD Setup Procedure.....	45
5.3 Ground Fault Detection	46
5.4 Motor Overload Protection	47
5.5 System Configuration	47
5.6 Start-Up and Shut-Down Ramp Times.....	49
5.7 Motor Control Methods (V/f vs. Torque Control Specific To V-Series Products).....	51
6 CONSTANT PRESSURE SYSTEMS.....	53
6.1 Control Principles of Constant Pressure Systems.....	53
6.2 PerfectPressure™ Setup – Analog Constant Pressure	57
6.3 Digital Constant Pressure Systems	58
6.4 Analog Constant Pressure Systems	61
6.5 Pre-Charge Mode	65
6.6 Lead/Lag Pump Control	66
6.7 Duplex / Multiplex Control	69
6.8 Troubleshooting Constant Pressure Systems	72
7 TROUBLESHOOTING	73
7.1 Fault Codes	73
7.2 Clearing a Fault	74
8 ROUTINE INSPECTION AND MAINTENANCE	78
9 MODELS AND RATINGS	85
9.1 Model Nomenclature	85
9.2 Model Ratings.....	89
9.3 Dimensional Drawings.....	100
WARRANTY POLICY	111

1 INTRODUCTION

Phase Technologies' variable frequency drives (VFDs) are inverter-based devices that convert AC power to a three-phase variable frequency output which provides speed control for three-phase AC motors. The drives offer advanced motor control features through an intuitive, easy to use interface. All models can be ordered with a variety of optional equipment installed by Phase Technologies' certified 508A panel shop.

The following block diagrams demonstrate how the drives convert incoming AC power to DC, then utilize an inverter module to generate three-phase variable voltage and frequency output to control the speed of the primary motor. When equipped with optional AUX POWER™ (1LH Series only) an auxiliary inverter module and sine wave filter produce sinusoidal three-phase, 480 V, 60 Hz power. This output is designed primarily to power a center pivot irrigation system. AUX POWER™ voltage is clean enough to operate virtually any load, even sensitive electronics.

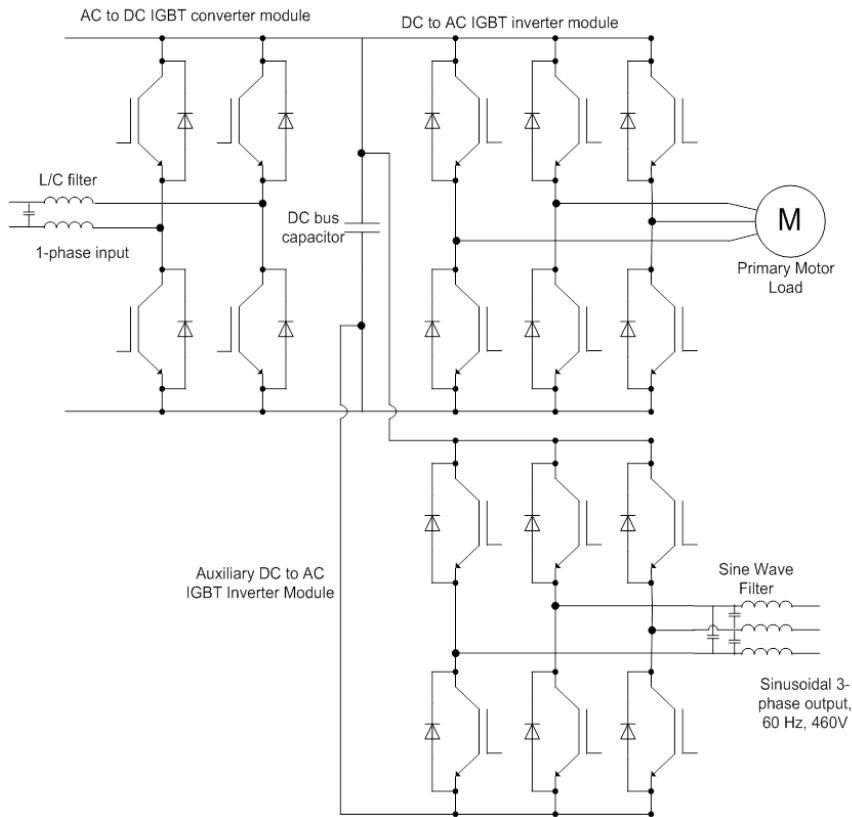

Figure 1 – 1LH Series with Optional AUX POWER™ Block Diagram

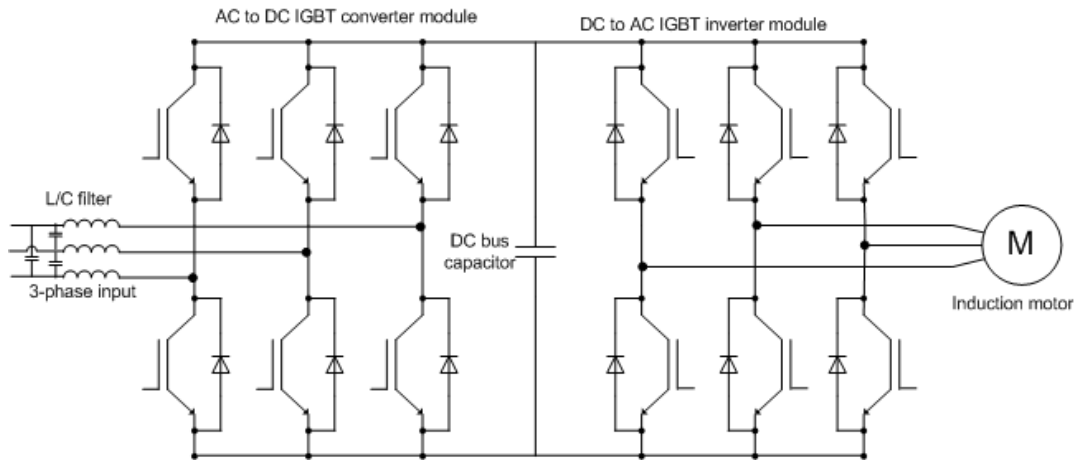

Figure 2 – 3LH Series Block Diagram

The simplified block diagram below demonstrates how the DX Series drive converts the incoming three-phase AC power to DC. FIGURE 4 shows how the 1DX and SDE drives convert incoming single-phase AC power to DC. Then both systems utilize an inverter module to generate three-phase variable voltage and frequency output to control the speed of the motor.

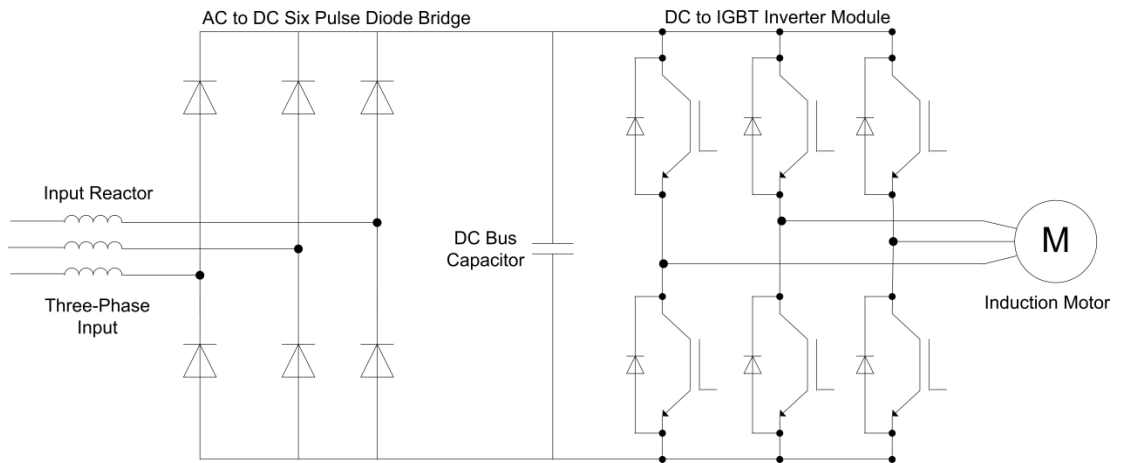

Figure 3 – DX Series Block Diagram

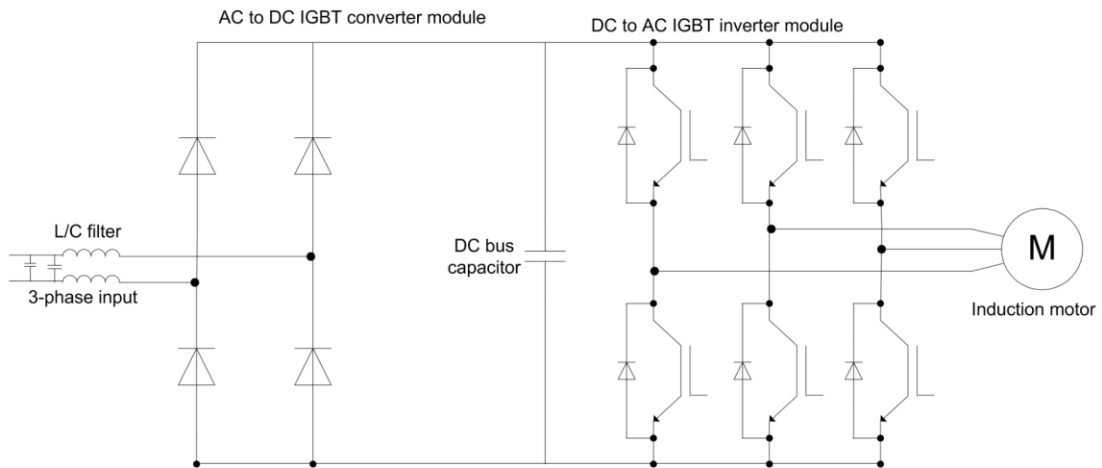

Figure 4 – 1DX and SDE Series Block Diagram

FEATURES

Low Line Side Harmonics (IEEE 519-2014 Compliant) – 1LH & 3LH Models Only

All models of the LH series employ active front end (AFE) technology. Active switching of the input IGBTs allows the drive to draw the input current as a sine wave, greatly reducing the current distortion and line harmonics associated with a diode bridge rectifier. Because of its favorable harmonic profile, input line reactors and harmonic filters are NOT REQUIRED on the line side of the drive. Installations at 50% load or greater will comply with IEEE 519, the international standard for allowable harmonic distortion on utility mains.

Voltage Doubling – 1LH & 3LH Models Only

Unlike a diode bridge rectifier, the input module is capable of significantly boosting the voltage on the DC bus. Utilizing this feature, some models of the series convert 240 V, single-phase or 240 V, three phase line voltage to 480 V, three-phase output.

Input Reactor

An input reactor is a standard feature on LH Series VFD's and optional on some DX models. The input reactor is an inductor connected in series between the input terminals and the diode or IGBT rectifier. The input reactor reduces harmonics on the input lines, protects the input stage from current surges, and reduces ripple current on the DC bus. It offers some protection against voltage transients, but installation of a surge protective device (SPD) is recommended to protect the system from surges.

Superior Heat Rejection: Indirect Cooling

The drive and enclosure are thermally engineered with an indirect cooling design. Assembled as one unit, the design directs air flow over critical heat-producing components while isolating sensitive components from outside ambient air. Most other outdoor 3R rated drives integrate a NEMA 1 indoor VFD in an outdoor enclosure without segregating the airflow. With this design, the drive and other sensitive components can degrade due to re-circulated hot air and contaminants from outside air.

OPTIONAL EQUIPMENT

Molded Case Circuit Breaker (MCCB)

Drives are available with an optional MCCB integrated into the panel. The breaker is equipped with an external service-rated disconnect.

Surge Arrestor

An optional surge arrestor is recommended in the panel, on the line side of the drive, to protect the input stage from damage due to voltage spikes on the utility supply. Phase Technologies offers a high-quality surge protective device (SPD) as an installed option. Damage from input voltage spikes is not covered under warranty when SPDs are not installed or when an SPD not approved by Phase Technologies is installed. Contact Phase Technologies for more information.

⚠ CAUTION: The proper phase-to-ground voltage on the input lines is critical when specifying Strikesorb® SPDs. Consult with Phase Technologies before ordering this option. Improper installation can damage the drive and is not covered under warranty.

Output Filters

Some installations may require a load reactor, dV/dt filter, or sine wave filter between the drive and the motor. **Output filters are necessary when motor leads exceed 50 ft.** Without filters, long leads allow reflected harmonics to create dangerous voltage spikes that can exceed the insulation rating of the motor cables and windings. Over time, these voltage spikes will degrade the insulation and result in motor faults. Output dV/dt or sine filters are standard options on most Phase Technologies drives. A filter reduces harmonics in the PWM output voltage, smoothing the waveforms to reduce vibration in the motor. Filters also reduce common mode currents in the motor windings that can discharge through motor bearings, causing pitting and premature motor failure.

Hand/Off/Auto (HOA) Switch with Speed Pot

All LH-DX-SDE models are available with an external mounted HOA switch and speed potentiometer. When the switch is in the **Hand** (Manual) position, the speed pot can be used to control motor speed on the main motor output of the drive. In the **Auto** position, the main output is controlled by external control signals through the various analog and digital inputs to the drive. For example, if the drive were configured in constant pressure control mode, the 4-20 mA signal from the pressure transducer would control motor speed. The HOA switch in the **OFF** position will stop the motor on the main output of the drive. The secondary drive output, AUX POWER™, will not be affected. It is controlled by another external switch on the panel door.

Auxiliary Power Supply

An auxiliary power supply is available as an option on most drives in the series. The supply is rated 240/120 VAC, 0.5 Amps. Power is accessed through a second terminal block.

AUX POWER™ (1LH Series Only)

Phase Technologies has designed a VFD that provides full-featured speed control of the main motor load and AUX POWER™, an independently controlled phase converter to power an entire center pivot irrigation system. The converter provides pure sinusoidal power rated 60 Hz, 460V three-phase, and is safe to power virtually any load, even sensitive electronics. The AUX POWER™ converter is available in two sizes, 18 Amps or 32 Amps. This option is only available on 1LH Series drives.

2 INSTALLATION

2.1 Mounting

The drive must be mounted in an upright position with adequate clearance for cooling and maintenance access. The mounting surface must be sturdy and capable of bearing the weight of the unit. Fasten the unit to the mounting surface using screws or bolts of an appropriate size through the holes on the mounting brackets. The enclosure can be wall mounted or pad mounted. Brackets for wall mounting are standard, but optional legs can be ordered for pad mounting. Lifting hooks are provided on the top of the enclosure.

To allow for proper cooling and air circulation around the enclosure, maintain minimum clearance of 6 inches on the sides and top and 18 inches below. The drives are cooled by fans with ventilation openings on the side and bottom of the enclosure. The air is pulled in the bottom of the enclosure and expelled out the side. The surface around the enclosure should be of a non-flammable material and clear of obstacles. Locate the drawing of your drive model in **Section 9.3** for determining dimensions, hole mounting location and clearance.

⚠ CAUTION: Failure to maintain adequate clearance may lead to overheating of the unit and cause damage or fire.

⚠ CAUTION: These drives are intended for use in an ambient temperature no higher than 50°C.

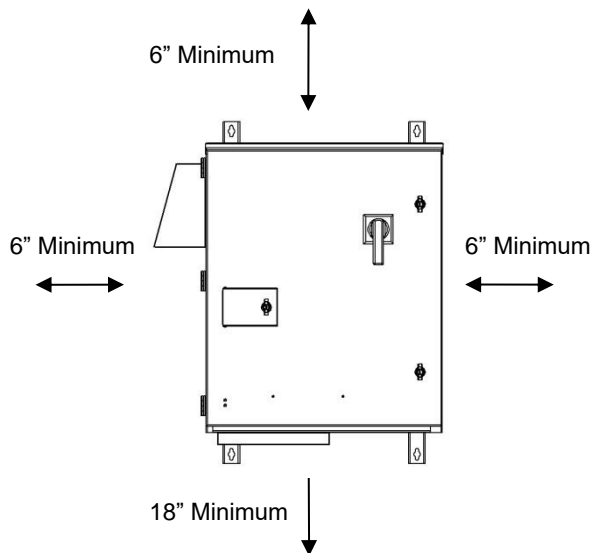

Figure 5 – Minimum Clearances

Ambient Temperature Rating

These drives are intended for use in an ambient temperature no higher than 50°C*.

*The following models are only rated 40°C: **1LH4100C & 3LH4200**

2.2 General Wiring Considerations

Installations must comply with all NEC and local electrical code requirements.

Table 1 – Power Terminal Descriptions

Terminal Name	Description
L1, L2, L3	Input power terminals
U, V, W	Output power terminals
T1, T2, T3	AUX POWER™ output terminals
GND	Earth safety ground

Table 2 – Field Wiring Power Terminal Specifications – Input Terminals

Input Power Terminals							
Model							
1LH220, 1LH230, 1LH420, 1LH420C, 1LH420X, 1LH430, 1LH430C, 1LH430X, 1LH440, 1LH440C, 1LH450, 1LHS220, 1LHS230, 1LHS420, 1LHS430, 1LHS440, 1LHS450	3LHS220R, 3LHS230R, 3LHS240R, 3LHS250R, 3LHS260R, 3LH220, 3LH230, 3LH240, 3LH250, 3LH420, 3LH430, 3LH440, 3LH450, 3LH460, 3LH475, 3LH4100	1LHS240, 1LHS250, 1LH220C, 1LH220X, 1LH230C, 1LH440X, 1LH450C, 1LH450X, 1LH460, 1LH460C, 1LH460X, 1LH475, 1LH475C, 1LH4100, 1LHS460, 1LHS475, 1LHS4100	1LH475X, 1LH4100C, 1LH4125	3LH4200, 3LH4250, 3LH4300, 3LH4350, 3LH4400, 3LH4450, 3LHS4200, 3LHS4200	1LHE005, 1LHE007, 1LHE010, 1LHE015, 1LHE205, 1LHE207, 1LHE210, 1LHE405, 1LHE407, 1LHE410, 1LHE420, 1LHE425	3LHE005, 3LHE007, 3LHE010, 3LHE015, 3LHE020, 3LHE205, 3LHE207, 3LHE210, 3LHE215, 3LHE220, 3LHE225, 3LHE405, 3LHE407, 3LHE410, 3LHE415, 3LHE420, 3LHE425, 3LHE430, 3LHE440	SDE007
DX420, DX430, DX440, DX450, DX460, DX475, DX4100	1LHE015, 1LHE020, 1LHE215, 1LHE220, 1LHE225, 1LHE430, 3LHE025, 3LHE030, 3LHE450	3LH4125, 3LH4150, 3LHS4125, 3LHS4150, 3LHS260	DX4250, DX4300, DX4350, DX4450	DXE005, DXE007, DXE010, DXE015, DXE020, DXE025, DXE030, DXE405, DXE407, DXE410, DXE415, DXE420, DXE425, DXE430, DXE440, DXE450	SDE405, SDE407, SDE410, SDE415		
DXS420, DXS430, DXS440, DXS450, DXS460, DXS475, DXS4100		DXS4125, DXS4150, DXS4200					
1DXS420, 1DXS430, 1DXS440		1DXS450, 1DXS460 1DXS475					
SDE410, SDE415							
Wire Size	Torque	Wire Size	Torque	Wire Size	Torque	Wire Size	Torque
2/0 AWG - 6AWG	120 in-lb	350 kcmil – 6 AWG	275 in-lb	500 kcmil – 4 AWG	375 in-lb	4 AWG - 18 AWG	16 in-lb
8 AWG	40 in-lb						
10 – 14 AWG	35 in-lb						

For a given terminal, **do not** use conductors larger than the maximum allowable size indicated in **Table 2** above.



AUX POWER™ auxiliary output terminals

⚠ CAUTION: Route the AUX POWER™ cables out the side of the enclosure directly across from the terminals. Do not route these cables near the main motor output cables. Electrical noise from the main motor output cables can couple onto AUX POWER™ cables, degrading the power quality.

Main motor output terminals

Figure 6 – Performance Series Power Terminal Location



Figure 7 – Signature Series Output Power Terminal Locations

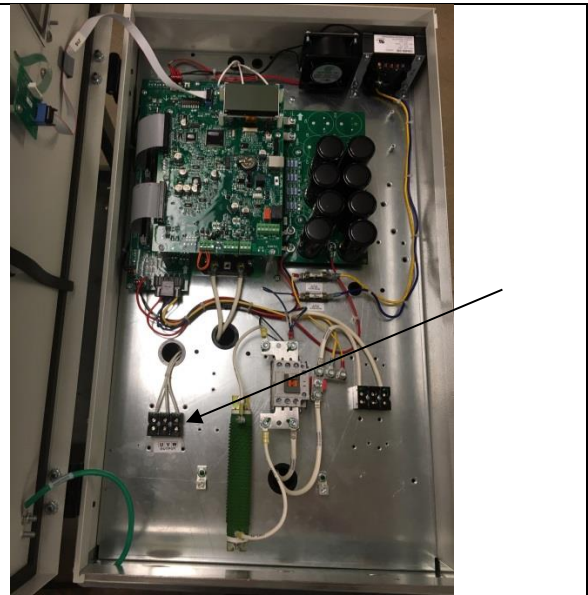

Figure 8 - Enterprise Series Output Power Terminal Locations

Table 3 – Field Wiring Power Terminal Specifications – Output Terminals

Output Power Terminals									
Model									
1LH220, 1LH220C, 1LH220X, 1LH230, 1LH230C, 1LH230X, 1LH240, 1LH420, 1LH420C, 1LH420X, 1LH430, 1LH430C, 1LH430X, 1LH440, 1LH440C, 1LH440X, 1LH450, 1LH450C, 1LH450X, 1LH460, 1LH460C, 1LH460X, 1LH475, 1LH475C		1LH250, 1LH475X, 1LH4100, 1LH4100C, 1LH4125		3LH2100, 3LH250, 3LH4200		3LHE005, 3LHE007, 3LHE010, 3LHE015, 3LHE020		1LHE005, 1LHE007, 1LHE010, 1LHE015, 1LHE020	
1LHS220, 1LHS230, 1LHS420, 1LHS430, 1LHS440, 1LHS450, 1LHS460, 1LHS475						3LHE205, 3LHE207, 3LHE210, 3LHE215, 3LHE220, 3LHE225		1LHE205, 1LHE207, 1LHE210, 1LHE215, 1LHE220, 1LHE225	
3LH220, 3LH230, 3LH240, 3LH250, 3LH420, 3LH430, 3LH440, 3LH450, 3LH460, 3LH475, 3LH4100, 3LHS220, 3LHS230, 3LHS240, 3LHS250150, 3LHS420, 3LHS430, 3LHS440, 3LHS450, 3LHS460, 3LHS475, 3LHS4100		1LHS240, 1LHS4100		3LHS4200		3LHE405, 3LHE407, 3LHE410, 3LHE420, 3LHE425, 3LHE430, 3LHE440		1LHE405, 1LHE407, 1LHE410, 1LHE420, 1LHE425, 1LHE430	
3LHE025, 3LHE030, 3LHE450								DXE405, DXE407, DXE410, DXE415, DXE420, DXE425, DXE430, DXE440, DXE450	
DX420, DX430, DX440, DX450, DX460, DX475, DX4100		3LH260, 3LH260, 3LH275, 3LH4125, 3LH4150, 3LHS4125, 3LHS4150, 3LHS260		DX4200, DXS4200		DXE005, DXE007, DXE010, DXE015, DXE020, DXE025, DXE030		SDE007, SDE010, SDE015	
DXS420, DXS430, DXS440, DXS450, DXS460, DXS475, DXS4100, DXS4125, DXS4150, DXS4200								SDE405, SDE407, SDE410, SDE415	
1DXS420, 1DXS430, 1DXS440, 1DXS450, 1DXS460, 1DXS475									
Wire Size	Torque	Wire Size	Torque	Wire Size	Torque	Wire Size	Torque		
2/0 – 6 AWG	120 in-lb	350 kcmil - 6 AWG	275 in-lb	500 kcmil - 4 AWG	375 in-lb	4 - 18 AWG	16 in-lb		
8 AWG	40 in-lb								
10 – 14 AWG	35 in-lb								

For a given terminal, **do not** use conductors larger than the maximum allowable size indicated in **Table 3** above.

Table 4 – Input Circuit Breaker and Fuse Ratings (Inverse Time Circuit Breaker)

Model	Maximum Fuse Rating Class J	Maximum Circuit Breaker Rating Amps*
1LH (Performance Series), 1LHS (Signature Series), & 1LHE (Enterprise Series)		
1LHE005	40 A, 600 V	40 A
1LHE007	60 A, 600 V	60 A
1LHE010	60 A, 600 V	60 A
1LHE015	100 A, 600 V	100 A
1LHE020	125 A, 600 V	125 A
1LHE205	40 A, 600 V	40 A
1LHE207	60 A, 600 V	60 A
1LHE210	70 A, 600 V	70 A
1LHE215	100 A, 600 V	100 A
1LH220, 1LHS220, 1LHE220	125 A, 600 V	125 A
1LH220C	200 A, 600 V	200 A
1LH220X	250 A, 600 V	250 A
1LHE225	150 A, 600 V	150 A
1LH230, 1LHS230	175 A, 600 V	175 A
1LH230C	250 A, 600 V	250 A
1LH230X	350 A, 600 V	350 A
1LH240, 1LHS240	250 A, 600 V	250 A
1LH240C	350 A, 600 V	350 A
1LHE405	20 A, 600 V	20 A
1LHE407	30 A, 600 V	30 A
1LHE410	40 A, 600 V	40 A
1LHE415	60 A, 600 V	60 A
1LH420, 1LHS420, 1LHE420	60 A, 600 V	60 A
1LH420C	100 A, 600 V	100 A
1LH420X	125 A, 600 V	125 A
1LHE425	80 A, 600 V	80 A
1LH430, 1LHS430, 1LHE430	100 A, 600 V	100 A
1LH430C	125 A, 600 V	125 A
1LH430X	175 A, 600 V	175 A
1LH440, 1LHS440	125 A, 600 V	125 A
1LH440C	175 A, 600 V	175 A
1LH440X	200 A, 600 V	200 A
1LH450, 1LHS450	175 A, 600 V	175 A
1LH450C	200 A, 600 V	200 A
1LH450X	250 A, 600 V	250 A
1LH460, 1LHS460	200 A, 600 V	200 A
1LH460C	250 A, 600 V	250 A
1LH460X	250 A, 600 V	250 A
1LH475, 1LHS475	250 A, 600 V	250 A
1LH475C	250 A, 600 V	250 A
1LH475X	350 A, 600 V	350 A
1LH4100, 1LHS4100	300 A, 600 V	300 A
1LH4100C	350 A, 600 V	350 A
1LH4125	350 A, 600 V	350 A

Model	Maximum Fuse Rating Class J	Maximum Circuit Breaker Rating Amps*
3LH (Performance Series), 3LHS (Signature Series), & 3LHE (Enterprise Series)		
3LHE005	30 A, 600 V	30 A
3LHE007	30 A, 600 V	30 A
3LHE010	40 A, 600 V	40 A
3LHE015	60 A, 600 V	60 A
3LHE020	80 A, 600 V	80 A
3LHE025	100 A, 600 V	100 A
3LHE030	125 A, 600 V	125 A
3LHE205	30 A, 600 V	30 A
3LHE207	30 A, 600 V	30 A
3LHE210	40 A, 600 V	40 A
3LHE215	60 A, 600 V	60 A
3LH220, 3LHS220, 3LHE220	80 A, 600 V	80 A
3LHE225	100 A, 600 V	100 A
3LH230, 3LHS230	125 A, 600 V	125 A
3LH240, 3LHS240	175 A, 600 V	175 A
3LH250, 3LHS250	200 A, 600 V	200 A
3LHE405	20 A, 600 V	20 A
3LHE407	20 A, 600 V	20 A
3LHE410	30 A, 600 V	30 A
3LHE415	30 A, 600 V	30 A
3LH420, 3LHS420, 3LHE420	40 A, 600 V	40 A
3LHE425	60 A, 600 V	60 A
3LH430, 3LHS430, 3LHE430	60 A, 600 V	60 A
3LH440, 3LHS440, 3LHE440	80 A, 600 V	80 A
3LH450, 3LHS450, 3LHE450	100 A, 600 V	100 A
3LH460, 3LHE460	125 A, 600 V	125 A
3LH475, 3LHE475	150 A, 600 V	150 A
3LH4100, 3LHE4100	200 A, 600 V	200 A
3LH4125, 3LHE4125	250 A, 600 V	250 A
3LH4150, 3LHE4150	250 A, 600 V	250 A
3LH4200, 3LHE4200	350 A, 600 V	350 A
3LH4250	400 A, 600 V	400 A
3LH4300	500 A, 600 V	500 A
3LH4350	600 A, 600 V	600 A
3LH4400	600 A, 600 V	600 A
3LH4450	800 A, 600 V	800 A

Model	Maximum Fuse Rating Class J	Maximum Circuit Breaker Rating Amps*
DX (Performance Series), DXS (Signature Series) , & DXE (Enterprise Series)		
DXE005	30 A, 600 V	30 A
DXE007	30 A, 600 V	30 A
DXE010	40 A, 600 V	40 A
DXE015	60 A, 600 V	60 A
DXE020	80 A, 600 V	80 A
DXE025	100 A, 600 V	100 A
DXE030	125 A, 600 V	125 A
DXE405	20 A, 600 V	20 A
DXE407	20 A, 600 V	20 A
DXE410	30 A, 600 V	30 A
DXE415	30 A, 600 V	30 A
DX420, DXS420, DXE420	40 A, 600 V	40 A
DXE425	50 A, 600 V	50 A
DX430, DXS430, DXE430	60 A, 600 V	60 A
DX440, DXS440, DXE440	80 A, 600 V	80 A
DX450, DXS450, DXE450	100 A, 600 V	100 A
DX460, DXS460	125 A, 600 V	125 A
DX475, DXS475	150 A, 600 V	150 A
DX4100, DXS4100	200 A, 600 V	200 A
DX4125, DXS4125	225 A, 600V	225 A
DX4150, DXS4150	250 A, 600 V	250 A
DX4200, DXS4200	350 A, 600 V	350 A
DX4250, DXS4250	400 A, 600 V	400 A
DX4300, DXS4300	500 A, 600 V	500 A
DX4350, DXS4350	600 A, 600 V	600 A
DX4400, DXS4400	600 A, 600 V	600 A
DX4450, DXS4450	700 A, 600 V	700 A
1DXS420	40 A, 600 V	40 A
1DXS430	60 A, 600 V	60 A
1DXS440	80 A, 600 V	80 A
1DXS450	100 A, 600 V	100 A
1DXS460	125 A, 600 V	125 A
1DXS475	150 A, 600 V	150 A

Model	Maximum Fuse Rating Class J	Maximum Circuit Breaker Rating Amps*
SDE (Enterprise Series)		
SDE007	80 A, 600 V	80 A
SDE010	100 A, 600 V	100 A
SDE015	120 A, 600 V	120 A
SDE405	40 A, 600 V	40 A
SDE407	60 A, 600 V	60 A
SDE410	60 A, 600 V	60 A
SDE415	80 A, 600 V	80 A

2.3 Installing Power Cables

⚠ CAUTION: Continuous metal conduit should be used on all power cables, both line and load side, to reduce conducted and emitted radiation of electromagnetic interference (EMI). The conduit must be securely grounded to the enclosure of the drive and the motor case.

Mitigating Electromagnetic Interference (EMI)

Devices that utilize power switching electronics, such as VFDs, produce high frequency emissions commonly known as electromagnetic interference (EMI). These emissions can be conducted on power cables or emitted (radiated) through the air. Conducted and emitted noise can sometimes interfere with radio signals or sensitive electronic equipment near the installation. The use of shielded cables and rigid metal conduit on the output lines between the drive and the motor is recommended to help reduce EMI.

When it is not practical to use continuous metal conduit, special shielded cables can be used. The shielded cable should be constructed with symmetrical conductors and a copper or aluminum shield covered with an insulating jacket. A good shield results in lower EMI and lower motor bearing currents.

Routing Power Cables

Power cables should enter only through the bottom of the drive enclosure directly beneath the power terminals. Enclosures are supplied with conduit openings.

Do not install line-side power cables in the same conduit or cable tray with load side power cables. Also, do not route control cables through the same conduit or cable tray as power cables.

Routing Control Wires

A separate, smaller conduit opening is supplied for control cables. If the control cables must intersect the power cables, make sure they cross at right angles.

⚠ CAUTION: Avoid routing control cables near power cables to avoid coupling EMI onto control cables.

⚠ CAUTION Use an appropriately sized hole punch. Do not use a hole saw to create openings! Metal filings may damage the drive and void the warranty.

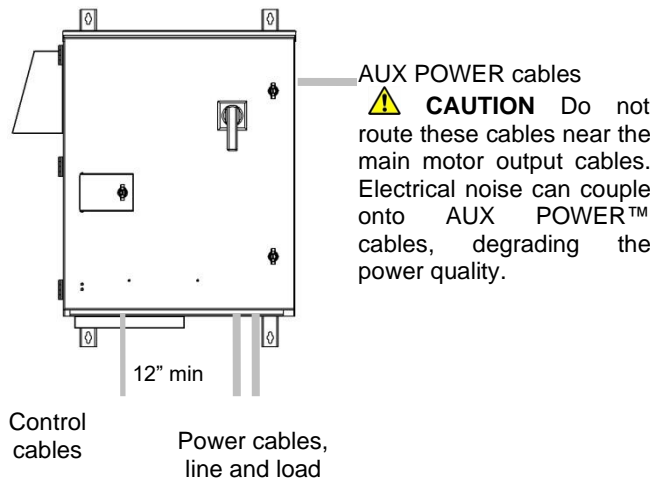



Figure 9 – Routing Power Cables

Output Filters

Some installations may require a dV/dt filter or sine wave filter between the drive and the motor. **Output filters are typically only necessary on 480 V drives, when motor leads exceed 150 ft.** Without filters, long leads allow reflected harmonics to create dangerous voltage spikes that can exceed the insulation rating of the motor cables and windings. Over time, these voltage spikes will degrade the insulation and result in motor failure.

A filter reduces harmonics in the PWM output voltage, smoothing the waveforms to reduce vibration in the motor. Filters also reduce common mode currents in the motor windings that can discharge through motor bearings, causing pitting and premature motor failure.

 **CAUTION:** Long leads between the unit and the motor with an unfiltered PWM voltage can lead to dangerous voltage rise from reflected harmonics. Very long leads, such as in deep well submersible pump applications, may require the use of a sine wave filter to remove most of the harmonics from the waveform. Consult the factory or a knowledgeable source on drive filters if your application has more than 150 feet between the drive and the motor.

2.4 Control Terminals

The drives are equipped with Control Terminals that allow several control functions, including remote ON/OFF control, digital output signals, remote notification, and operation of constant pressure water systems. **The correct *SYSTEM CONFIG* must be selected for proper operation of the different types of control systems!** See **Table 17**.

 **WARNING:** Do not connect Control Terminals to external circuits with voltage greater than that specified for each Control Terminal in **Table 5**. Disconnect all incoming sources of power, and then wait 10 minutes for internal charges to dissipate before servicing the equipment.

 **CAUTION:** The AUX1 – AUX4 terminals are galvanically isolated, with approximately 5 V potential between them. **DO NOT** apply a voltage to the terminals. Use dry contacts only.

Customer terminals are located on the Control Board of each drive. **Figure 10 – Figure 12** show where the control terminals are located on the Control Board for each system.

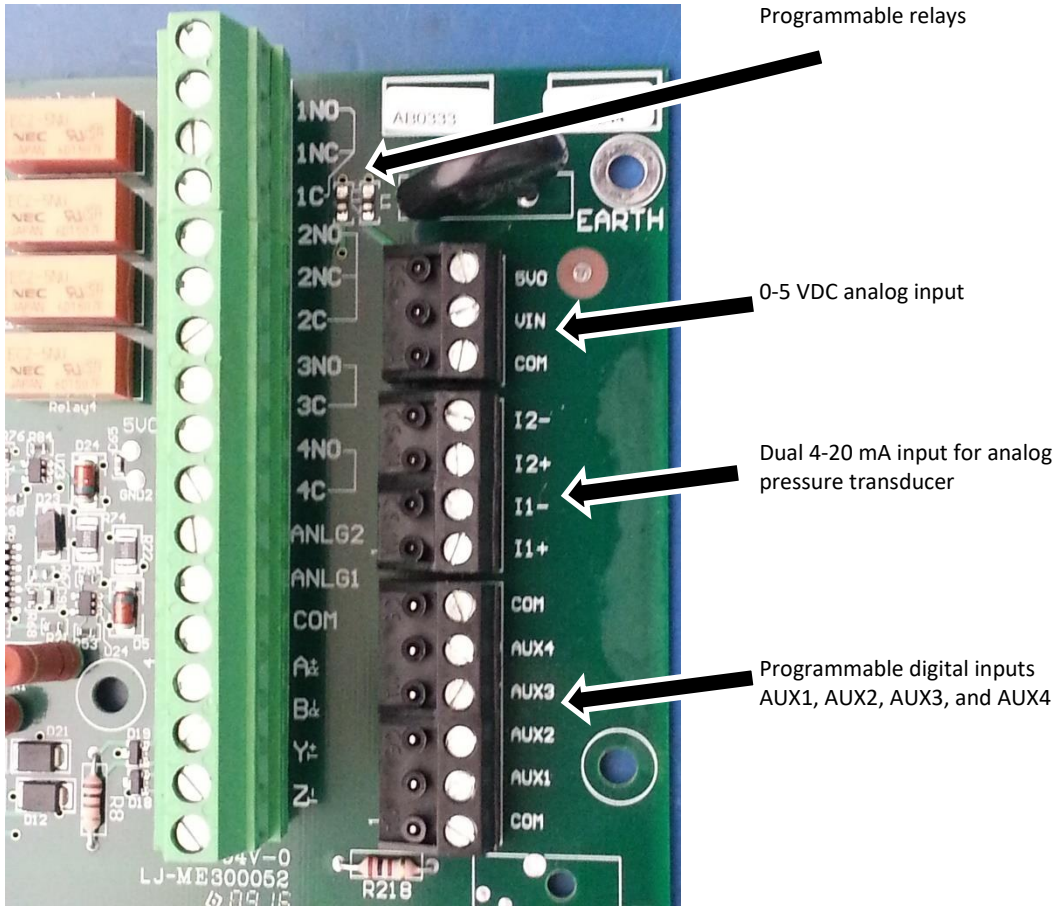

Figure 10 – Control Terminals – Performance Series

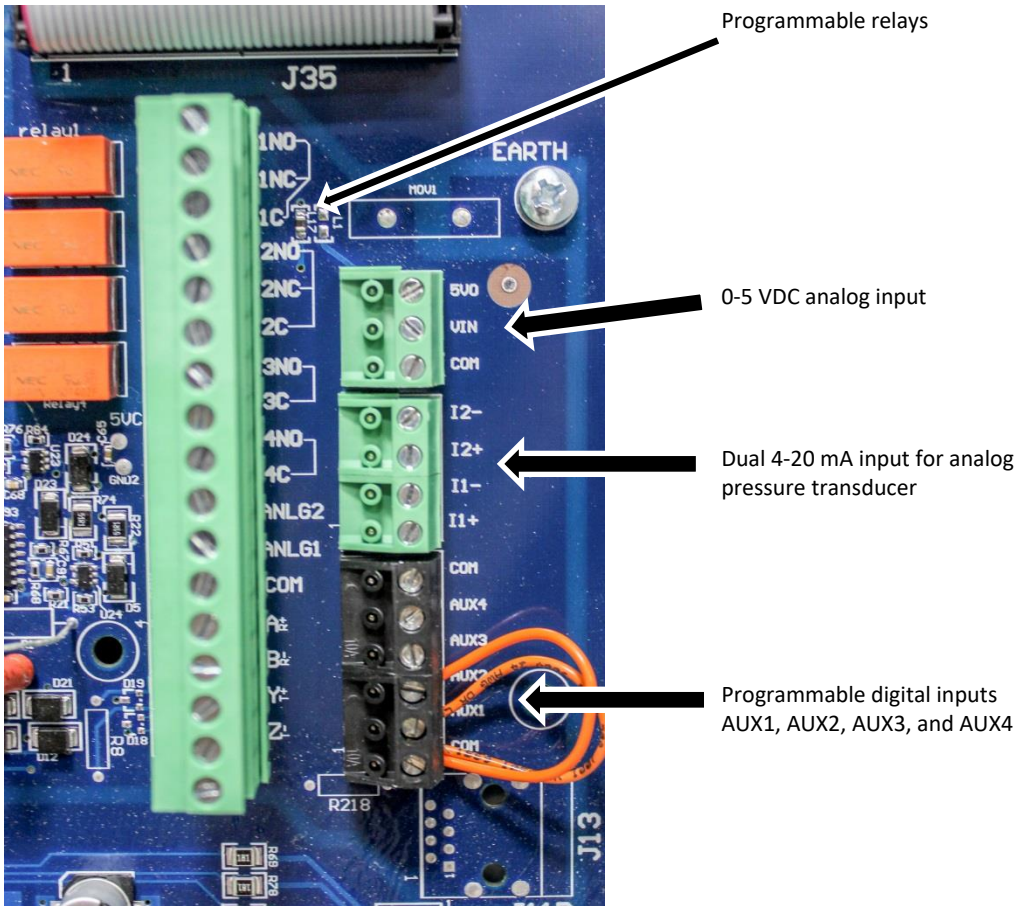
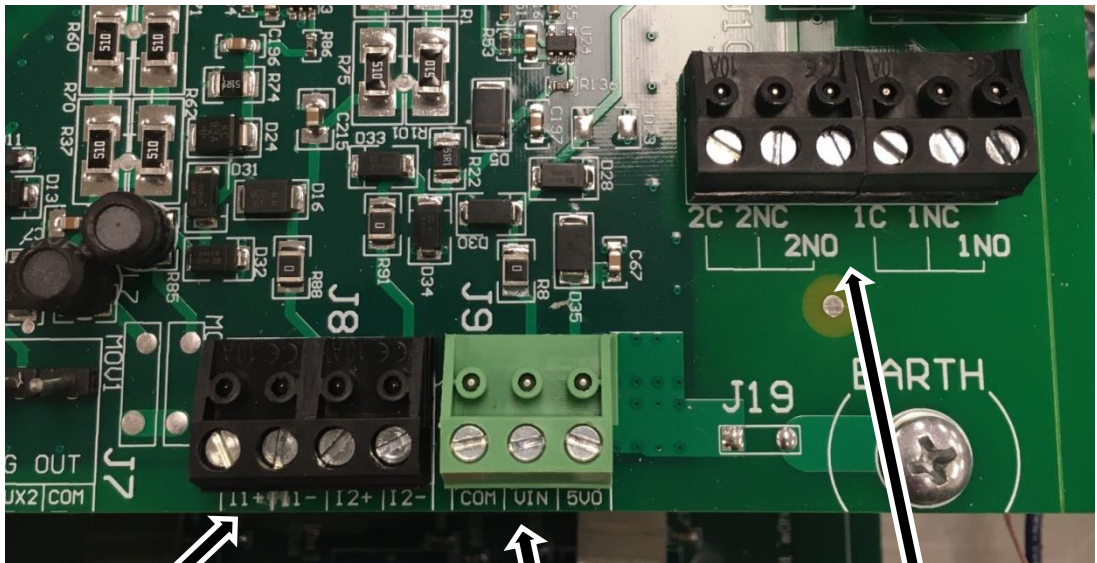

Figure 11 – Control Terminals – Signature Series



Dual 4-20 mA input for analog pressure transducer

0-5 VDC analog input

Programmable relays

Figure 12 – Control Terminals – Enterprise Series

On Enterprise Series drives, if HOA switch and speed pot options are installed from factory, control terminals will already be used and no additional controls can be installed.

See **Table 5** for information on the function of control terminals.

Table 5 – Control Terminal Ratings and Descriptions

Terminal Designator	Description	Rating	Comments
1NO	Normally Open Relay	0-30 VDC or 120VAC, 10A	Normally open relay controlled by the conditions set in Parameter PROGRAM RLY 1 . See Table 17 for instructions on programming this relay.
1NC	Normally Closed Relay		
1C	Common		Common terminal for 1NC and 1NO terminals. CAUTION: Do not use as common for other terminals.
2NO	Normally Open Relay		Normally open relay controlled by the conditions set in Parameter PROGRAM RLY 2 . See Table 17 .
2NC	Normally Closed Relay		Normally closed relay controlled by the conditions set in Parameter PROGRAM RLY 2 . See Table 17 .
2C	Common		Common terminal for 2NC and 2NO terminals. CAUTION: Do not use as common for other terminals.
3NO	Normally Open Relay	0-30 VDC or 120VAC, <250mA	Normally open relay controlled by the conditions set in Parameter PROGRAM RLY 3 . See Table 17 .
3C	Common		Common terminal for 3NO terminal. CAUTION: Do not use as common for other terminals.
4NO	Normally Open Relay		Normally open relay controlled by the conditions set in Parameter PROGRAM RLY 4 . See Table 17 .
4C	Common		Common terminal for 4NO terminal. CAUTION: Do not use as common for other terminals.

Table 5 – Control Terminal Ratings and Descriptions Continued

Terminal Designator	Description	Rating	Comments
AUX1	Auxiliary 1	< 5 Volts galvanically isolated	Programmable digital input. Commonly used for RUN/STOP command. See Table 17 .
AUX2	Auxiliary 2		
AUX3	Auxiliary 3		
AUX4	Auxiliary 4		
COM	Common		Common for all terminals except programmable relays.
I_1 in +	4-20 mA Positive	4-20 mA	Analog transducer connection for analog constant pressure or proportional motor speed control from a current source. Refer to Table 17 for details. See Figure 13 for a connection diagram to control terminals.
I_1 in –	4-20 mA Negative		
I_2 in +	4-20 mA Positive		
I_2 in –	4-20 mA Negative		
5 VO	0-5 VDC Output	0-5 VDC	5 VDC supply to provide power to a potentiometer. Refer to Table 17 or Section 5.5 for details. See Figure 14 for a connection diagram to control terminals.
V In	0-5 VDC Input		Analog input for motor speed control for 0-5 VDC. Speed is relative to scale of signal from 0 Hz to Maximum Frequency as set in Adjustable Parameter menu (factory default 60 Hz). Connect the wiper terminal of a potentiometer to this terminal. See Figure 14 for a connection diagram to control terminals.
COM	Common		Common for 0-5 VDC. See Figure 13 - Figure 15 for a connection diagram to control terminals.

4-20 mA Analog Input

Motor speed can be controlled with 4-20 mA analog input through control terminals **I_1** and **I_2**. A 4-20 mA pressure transducer is also commonly used for constant pressure control through these terminals.

4-20 mA Transducer Connection:

1. Using the keypad, set the value of parameter **SYSTEM CONFIG** to 2, 3, 4 or 6 depending on the desired mode of operation. See **Table 17 – Interface Parameters**, and **Section 5.5** for details.
2. Connect the positive lead of the transducer to terminal **I_1+** or **I_2+**
3. Connect the negative lead of the transducer to terminal **I_1-** or **I_2-**
4. AUX terminals must be closed to run.

4-20 mA Transducer with External Source Connection:

1. Using the keypad, set the value of parameter **SYSTEM CONFIG** to 2, 3, 4 or 6 depending on the desired mode of operation. See **Table 17 – Interface Parameters**, and **Section 5.5** for details.
2. Connect the positive lead of the transducer to terminal **I_1+** or **I_2+**
3. Connect the negative lead of the transducer to COM
4. AUX terminals must be closed to run.

⚠ CAUTION: A 4-20 mA transducer with the parameter **SYSTEM CONFIG** set at 6 results in linear speed control of the motor based on the analog signal from the transducer. This setting will not provide control of a constant pressure water system. For constant pressure control with 4-20mA transducer, refer to **Section 5.5**, System Configuration, and **Section 6** Constant Pressure Systems, for more information.

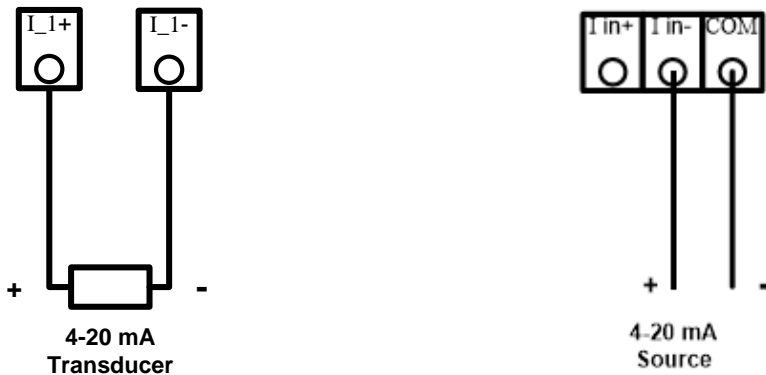

a. 4-20 mA Transducer Connection

b. 4-20 mA Transducer with External Source

Figure 13 – Control Terminal Connection Diagram for 4-20 mA Control

0-5 VDC Analog Input

Motor speed can be controlled with a 0-5 VDC signal through control terminals **5 VO**, **5 VI** and **COM**. When using a speed potentiometer (variable resistor) the drive provides a DC source voltage. Speed control can also be accomplished with an external DC voltage signal.

Potentiometer connection:

1. Using the keypad, set the value of parameter **SYSTEM CONFIG** to 5 or 7. Refer to **Table 17 – Interface Parameters**, Interface Parameters, or **Section 5.5**, System Configuration, for details.
2. Connect the negative lead of the potentiometer to COM
3. Connect the wiper terminal of the potentiometer to V IN
4. Connect the positive lead of the potentiometer to 5 VO
5. AUX terminals must be closed to run

External DC voltage signal:

1. Set parameter **SYSTEM CONFIG** to 5.
2. Connect negative lead to COM
3. Connect positive lead to V IN

⚠ CAUTION: The resistance value of the transducer must be from 5,000 ohms to 20,000 ohms. Resistance below 5,000 ohms will produce a high current in the circuit and may damage components in the circuit.

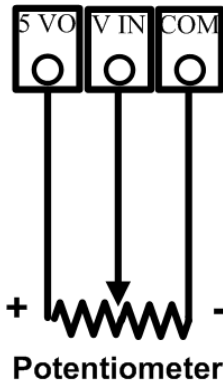

a. Potentiometer Connection Diagram

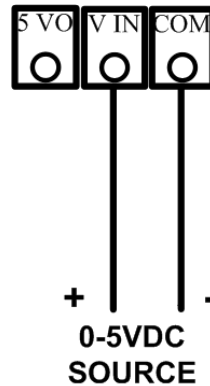

b. External DC Voltage Connection Diagram

Figure 14 – Control Terminal Connection Diagram for 0-5 VDC Control

Analog Constant Pressure with Potentiometer and HOA Switch

The drives can be configured with a HOA switch that allows the user to either turn the motor off, control motor speed with a potentiometer or operate in constant pressure mode. Access to the keypad is not required to operate in this mode.

1. Using the keypad, set the value of parameter **SYSTEM CONFIG** to 7. See **Table 17 – Interface Parameters**, for details.
2. Connect the potentiometer and 4-20 mA transducer as in **Figure 13** and **Figure 14**.
3. Connect a double pole, triple throw HOA switch to AUX1 and AUX3 as depicted in **Figure 15**.
4. Using the keypad, set the drive to operate in AUTO mode.
5. AUX2 and AUX4 must be closed to run.

The mechanical HOA switch allows the user to select between OFF, manual speed control with the potentiometer or analog constant pressure. In the H (Hand/Manual) position, motor speed is controlled by the potentiometer. In the O (Off) position the motor will stop. In the A (Auto) position motor speed will be controlled by constant pressure parameters.

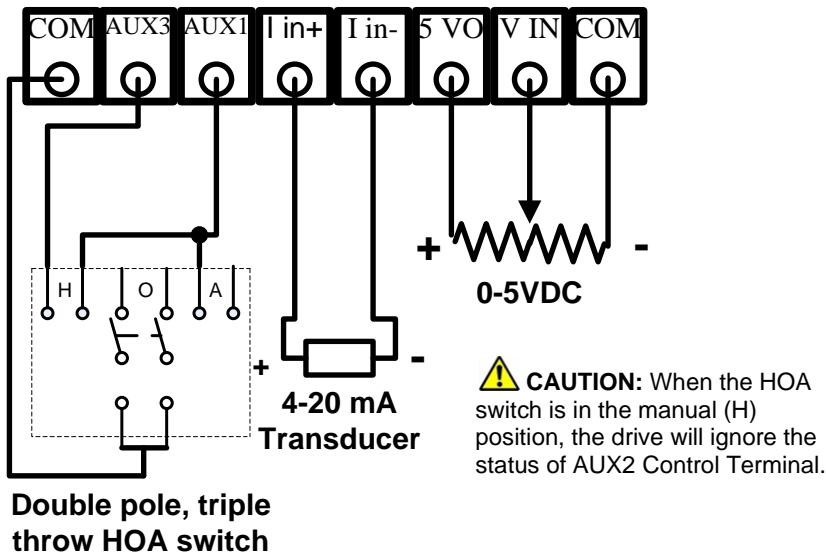

Figure 15 – Connections for Analog Constant Pressure with Potentiometer and HOA Switch

3 KEYPAD & DISPLAY

Before operating the motor load, several basic settings and procedures must be completed. If desired, extensive features for special operating conditions and for protection of the motor load are available through the keypad.

A power-up test should be performed before the unit and its load are placed in service. Refer to **Section 5.1**. Before initial power up, it is advisable to become familiar with setting motor overload protection, setting **SYSTEM CONFIG**, and with basic operation of the keypad and display.

3.1 Using the Keypad and Display

The drive is capable of many advanced, easy-to-use features that allow the user to protect the motor load from damage, monitor load conditions, log motor run time, troubleshoot the system, and more. The keypad and graphic display offer an intuitive interface specifically tailored for pumping applications.

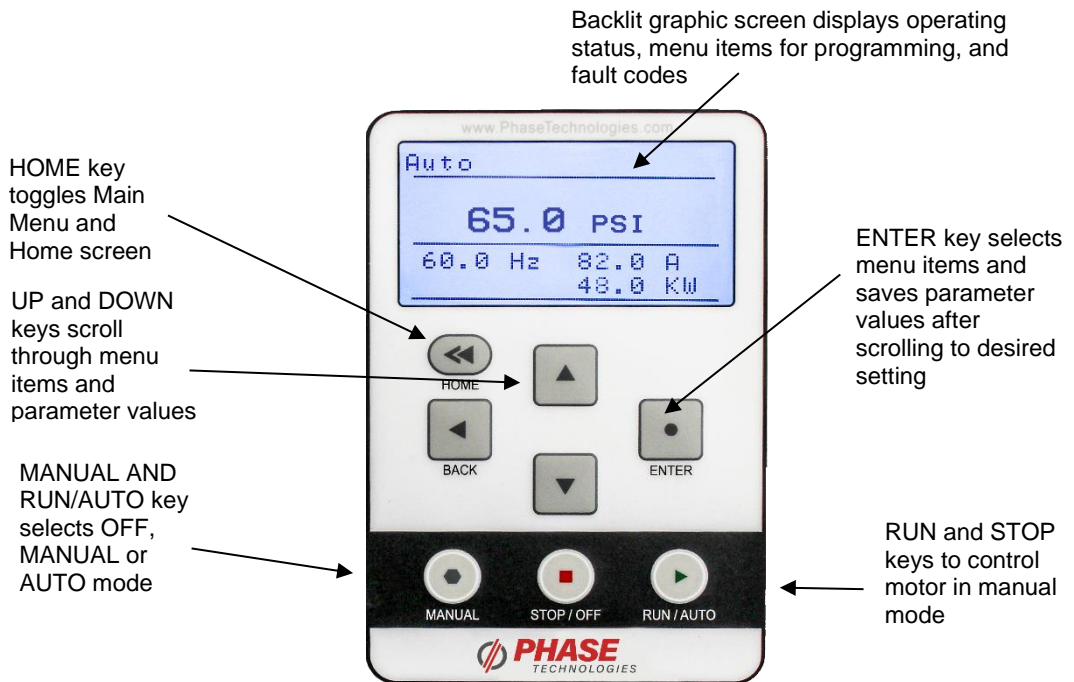

Figure 16 – Keypad and Graphic Display

Display Modes

After two minutes of keypad inactivity, the display will revert to the default display mode. Information on the display will vary based on the operating mode of the drive. When operating in AUTO mode with the factory default **SYSTEM CONFIG** set to 0, the display will indicate output kilowatts (kW), output amps (A), output frequency (Hz) and the status of the AUX1 and AUX2 inputs.



Password Protecting the Keypad

The keypad can be set up with a password to prevent unauthorized changes in adjustable parameters. The parameter **PASSWORD SETUP** (Table 17) is used to protect the keypad. When this parameter is set to 0 the keypad is not protected. Contact customer service at 605-343-7934 if you lose or forget the password.

Keypad Display Messages

Several messages will appear on the display when the unit is initially energized. When the unit has completed its start-up routine, the default display indicating the status of the OFF, AUTO, MAN mode will appear. Start-up display messages are detailed in Table 6 below.

Table 6 – Display of Operating Modes

MODE	DESCRIPTION
AUTO	<p>The factory default operating mode is OFF. The adjustable parameter, ENABLE RESTARTS, must be set to 1 to allow automatic re-starts. See Table 15 – Operating Parameters, for details.</p> <p> CAUTION: In AUTO mode, the motor load will automatically run if both AUX1 and AUX2 remote switches are closed. Open AUX1 or AUX2 to stop the motor or push STOP/OFF key.  CAUTION: By default, AUX1 and AUX2 are programmed to be always ON. See AUX1 SELECT and AUX2 SELECT to change this setting.</p>
MANUAL	<p>Activate MANUAL mode by pushing the MANUAL key until MANUAL appears on top left of the display. In MANUAL mode the motor load is controlled by using the RUN and STOP keys, which will override all external control signals.</p> <p>Manual control of the drive through the keypad can be disabled through the parameter DISABLE MANUAL. See Table 17 – Interface Parameters, for details.</p> <p> CAUTION: Operating the system in MANUAL mode on the keypad overrides signals from all external controls, including pressures switches. Operating the system in this mode may lead to dangerous operating conditions such as extreme pressure in closed plumbing systems.</p>
OFF	<p>The factory default operating mode is OFF. The adjustable parameter, ENABLE RESTARTS, must be set to 1 to allow automatic re-starts. To exit AUTO mode, press the STOP/OFF key until OFF appears on top left of the display. If the motor is running, it will stop. To restart the motor, revert to either AUTO mode or MANUAL mode. Certain faults can also be cleared by pressing the up and down arrow keys at the same time and holding for one second.</p>

3.2 Keypad Main Menu Items

The HOME key toggles between the Home screen (operating status screen) and the Main Menu items. Use the UP and DOWN arrows to scroll through the Main Menu items. Press ENTER to view or edit a Main Menu item. **Table 7** contains a brief description of Main Menu items, followed by in-depth instructions on the use and function of each Main Menu item.

Table 7 – Main Menu Items

DISPLAY MESSAGE	DESCRIPTION
CHANGE PARAMETER VALUES	Allows the user to set values for functions such as motor overload settings, dry well condition, time to restart after a fault, etc.
READ MEASURED VALUES	Displays measured values such as output current, input voltage, load power factor, etc.
READ TIMERS	Records motor run time and drive on time.
RESTART LOG	A re-settable fault log that records the number of times a particular fault has occurred. The number of faults counted in this log can be cleared through the CLEAR MEMORY menu.
FAULT LOG	Records the number of times a particular fault has occurred and records the time and date of the 20 most recent faults. FAULT LOG cannot be reset by the user.
CLEAR MEMORY	This function clears the Restart Log and Timers. <u>All</u> fault counters in the Restart Log will be reset to zero. If any number of automatic restarts have been allowed through parameters in the Auto Restart Parameters (Table 16), the counter on these faults will be set to zero.
SETUP WIZARD	This allows the user to quickly setup common control schemes: Constant Pressure Control, Flow Control, Tank Level Control, Pump Down Control, and Suction Pump Control. Using these wizards will allow adequate control of most systems, but if additional fine-tuning is needed, see lists of adjustable parameters in Section 4 .

3.3 Change Parameter Values

The Main Menu item, **CHANGE PARAMETER VALUES**, leads to several sub-menus that contain adjustable operating parameters. These parameters provide basic functions such as motor overload protection and advanced features that allow you to customize operation of the drive to fit your application.

Section 4, starting on page 31, contains a complete list of the parameters along with a description of their function and instructions on setting them.

3.4 Read Measured Values

The display can provide a variety of measured values related to the performance of the drive and its load, such as currents, horsepower, and power factor. To read measured values:

1. Press the HOME key to access Main Menu items, and then scroll with arrow keys until **READ MEASURED VALUES** appears on the display.
2. Press ENTER to access this menu item.
3. Use the up and down arrow keys to scroll through the various values that you wish to read.

Table 8 – Measured Values

DISPLAY MESSAGE	DESCRIPTION OF MEASURED VALUE
Iu Iv Iw	Three-phase currents on the output
OUTPUT HP	Output measured in horsepower
OUTPUT KW	Output measured in kilowatts
OUTPUT KVA	Output measured in kilovolt amperes
OUTPUT PF	Power factor of the motor load
BUS CAP VOLTAGE	Voltage of the DC bus
INPUT VOLTAGE	Input voltage AC
AUX1 AUX2	ON/OFF status of the remote switch circuits AUX1 and AUX2
AUX3 AUX4	ON/OFF status of the remote switch circuits AUX3 and AUX4
FREQUENCY	Output frequency in Hz
MODEL NUMBER	Indicates 1-phase or 3-phase input, model, voltage class, and HP e.g. 1-phase LH450 would indicate a low harmonic, phase converting, 480V, 50 HP drive.
V 5VDC Input	Measures the 0-5 VDC analog control voltage between Control Terminals for 0-5VDC input.
I_1 4-20mA Input	Measures 4-20 mA analog control current on I_1 Control Terminals for analog current input.
I_2 4-20mA Input	Measures 4-20 mA analog control current on I_2 Control Terminals for analog current input.
TIME UNTIL START	Displays a timer that counts down the time left to start when the drive is in a time delay due to a fault condition.
INPUT CURRENT	Current measured on the input of the drive.
AUXPOWER CURRENTS	AUXPOWER output current (only on models with this optional feature)
Real-time Clock	Date/Time
IGBT Case Temp	Insulated-gate bipolar transistor (IGBT) case temperature.

3.5 Read Timers

The timer function records motor run time in hours, and the time the drive has been energized. There are two timers for each function, one can be reset, and one permanent. To view and reset the timers:

1. Press MENU to scroll through menu items until **READ TIMERS** appears on the display.
2. Press ENTER to enter this menu item.
3. Use the up and down arrows to scroll through the clock functions.
4. To reset the clock timers, navigate to the Main Menu item, **CLEAR MEMORY**, press ENTER, and then use arrow keys to select **RESET TIMERS**. Press ENTER to reset the timers.

Table 9 - Timers

TIMER	DESCRIPTION
Motor Run Time	Logs motor run time in hours.
Drive On Time	Logs time in hours the drive is energized
All Motor Hours	Logs total motor run time. Not resettable.
All Drive Hours	Logs total time the drive is energized. Not resettable.



Programming Tip

To reset the timers, navigate to the Main Menu item, **CLEAR MEMORY**, use arrow keys to select **RESET TIMERS**, and then press ENTER

3.6 Restart Log

The Restart Log records the number of times each fault has occurred. The faults counters in the Restart Log are resettable and are tied to faults that allow programmable automatic restarts. These automatic restarts are programmed through the **AUTO RESTART PARAMETERS**, which is a sub-menu of the **CHANGE PARAMETER VALUES** Main Menu item.

For instance, in a water well pump application, it might be useful to protect the pump from dry well condition by setting the **DRY WELL KW** parameter (found in the **OPERATING PARAMETERS** menu) so that the drive shuts down and registers a **DRY WELL KW** fault in the Restart Log.

The drive can also be programmed to automatically restart after a delay to allow the well to recover. Both the delay time and number of restarts can be programmed in **AUTO RESTART PARAMETERS**. The Restart Log allows the user to monitor the type and number of faults that have occurred. If the number of dry well faults exceeds the number of automatic restarts allowed for that fault, the drive will remain OFF until the Restart Log is cleared, which resets ALL resettable fault counters.

To view the Restart Log:

1. Press the HOME key, then BACK key to scroll through menu items until **RESTART LOG** appears on the display.
2. Press ENTER to access this menu item.
3. Use the up and down arrows to scroll through the faults.
4. The fault will appear on the first row of the display, followed by the number of times that fault has occurred.

To clear the Restart Log and reset all Auto Restart fault counters:

1. Press the HOME key, then BACK key to scroll through the Main Menu items until **CLEAR MEMORY** appears on the display.
2. Press ENTER.
3. Use the up and down arrows to find **CLEAR RESTART LOG**.
4. Press ENTER to clear the Restart Log and reset all Auto Restart fault counters.

 **CAUTION:** Clearing the Restart Log through the **CLEAR MEMORY** menu will clear ALL faults in the Restart Log and all fault counters in the will be reset to zero. If any number of automatic restarts is allowed through parameters in the Auto Restart Parameters (**Table 16**); the counter on these faults will be set to zero.

When the drive has faulted and is programmed to automatically restart after a time delay, the display will count down the remaining time to start. Press both up arrow and down arrow for one second to interrupt the countdown and start the motor.

If the drive has faulted and no auto restart is allowed, the display will indicate the type of fault that has occurred on the top line and the second line will read **RESTART? ENTER**. Press ENTER to clear the fault and restart the load.

The number and type of faults are also recorded in the Fault Log. In this Log each fault is recorded with a time and date stamp (up to the most recent 20 faults). The Fault Log is permanent and cannot be cleared. See the following section for more information on the Fault Log.

3.7 Fault Log

The Fault Log is a permanent record of drive faults. The number of faults cannot be reset by the user. Faults will be stamped with the time and date the fault occurred, up to a total of 20 times for each fault. After the 20th fault, the oldest time-stamped fault will be replaced with the most recent.

The Fault Log is a Main Menu item. Navigate through the Main Menu items by pressing the MENU key repeatedly until FAULT LOG appears. Press ENTER to view the list of faults, using the arrow keys to scroll through the list. See Error! Reference source not found. for more information on viewing the Fault Log.



Programming Tip

A maximum of 20 time and date stamps can be applied to any given fault. After the 20th fault, the oldest fault time stamp will be erased and replaced by the most recent. The drive will continue to count faults up to a maximum of 9,999.

3.8 Clear Memory

The **CLEAR MEMORY** function in the Main Menu allows you to reset the timers that record motor run time and drive on time, and to reset the Restart Log which counts the number of each particular fault.

1. Press MENU to scroll through menu items until **CLEAR MEMORY** appears on the display.
2. Press ENTER to enter this menu item.
3. Use the up and down arrows to find either **RESET TIMERS** or **CLEAR RESTART LOG**.
4. Press ENTER to reset the selected function.

3.9 Setup Wizards

Setup Wizards allows users to quickly setup commonly used control schemes: Constant Pressure Control, Flow Control, Tank Level Control, Pump Down Control, and Suction Pump Control. The wizards will guide users through a list of commonly used parameters for the control method selected.

The Setup Wizard selection will be shown upon the first initialization of the VFD and can be accessed through the keypad at any time by scrolling through the Main Menu Items.

Using these wizards will allow adequate control of most systems, but if additional fine-tuning is needed, see lists of adjustable parameters in **Section 4**. See **Table 10 - Table 14** for Setup Wizard walkthroughs.

Table 10 – Constant Pressure Wizard

PROMPT	DESCRIPTION
Run Constant Pressure Wizard?	Press the “ Enter ” key to go through the wizard. Press “ Home ” key to return to Home screen.
4-20 mA PSI Sensor Range	This is the maximum value of the psi sensor being used. Phase Technologies sensors have a maximum value of 150 psi.
PSI Setpoint 1	The pressure, in psi, that the drive will attempt to maintain.
Sleep PSI	This value is <u>added</u> to the value PSI SETPOINT 1 . The combined pressure is the value the drive will stop the motor load at and enter sleep mode.
PSI Measurement Offset	This is used to calibrate the pressure that the VFD registers from transducer if a manual pressure measurement is not equal to VFD reading.
Wake Up PSI	This value is <u>subtracted</u> from PSI SETPOINT 1 and is the pressure when the VFD will start the motor load again.
Sleep Frequency	As Hz. This parameter value is <u>added</u> to the frequency set by the parameter MINIMUM FREQ . The combined value is the frequency at which drive will enter sleep mode when pressure is controlled at the set point.
Submersible Pump	ENABLE THIS FEATURE WITH SUMBERSIBLE PUMPS. Frequency will ramp from stop to the value set by parameter MIN FREQUENCY in one second. Submersible pumps suffer damage to the thrust bearing if operated below 30 Hz for more than 1 second.
Enable Restarts	Controls the ability of the drive to automatically restart after a fault.
Disable Manual Mode	Disables manual operation of the drive through the keypad.
Overcurrent Limit	Setting for motor overload protection, Trip Class 10 curve.

Table 11 – Flow Control Wizard

PROMPT	DESCRIPTION
Run Flow Control Wizard?	Press the “Enter” key to go through the wizard. Press “Home” key to return to Home screen.
GPM Measurement Multiplier	This value allows the GPM SETPOINT 1 to be increased by a factor of 10 or a factor of 100. If the GPM SETPOINT 1 is set to 20 GPM, you can increase it to 200 GPM or 2,000 GPM by increasing this parameter.
4-20 mA Sensor Range	This is the maximum value of the GPM sensor being used.
GPM Setpoint 1	The flow, in Gallons Per Minute (GPM), that the drive will attempt to maintain.
Sleep Flow	This value is <u>added</u> to the value GPM SETPOINT 1 . The combined flow is the value the drive will stop the motor load at and enter sleep mode.
GPM Measurement Offset	This is used to calibrate the flow that the VFD registers from transducer if a manual flow measurement is not equal to VFD reading.
Wake Up Flow	This value is <u>subtracted</u> from GPM SETPOINT 1 and is the flow when the VFD will start the motor load again.
Sleep Frequency	As Hz. This parameter value is <u>added</u> to the frequency set by the parameter MINIMUM FREQ . The combined value is the frequency at which drive will enter sleep mode when GPM is controlled at the set point.
Submersible Pump	ENABLE THIS FEATURE WITH SUMBERSIBLE PUMPS. Frequency will ramp from stop to the value set by parameter MIN FREQUENCY in one second. Submersible pumps suffer damage to the thrust bearing if operated below 30 Hz for more than 1 second.
Enable Restarts	Controls the ability of the drive to automatically restart after a fault.
Disable Manual Mode	Disables manual operation of the drive through the keypad.
Overcurrent Limit	Setting for motor overload protection, Trip Class 10 curve.

Table 12 – Tank Level Control Wizard

PROMPT	DESCRIPTION
Run Tank Level Control Wizard?	Press the “Enter” key to go through the wizard. Press “Home” key to return to Home screen.
Ft Measurement Multiplier	This value allows the Ft SETPOINT 1 to be increased by a factor of 10 or a factor of 100. If the Ft SETPOINT 1 is set to 20 ft, you can increase it to 200 ft or 2,000 ft by increasing this parameter.
4-20 mA Ft Sensor Range	This is the maximum value of the sensor being used.
Ft Setpoint 1	The height, in feet, that the drive will attempt to maintain.
Sleep Height	This value is <u>added</u> to the value Ft SETPOINT 1 . The combined height is the value the drive will stop the motor load at and enter sleep mode.
Ft Measurement Offset	This is used to calibrate the height that the VFD registers from transducer if a manual height measurement is not equal to VFD reading.
Wake Up Height	This value is <u>subtracted</u> from Ft SETPOINT 1 and is the height when the VFD will start the motor load again.
Analog I1 Inverted	Inverts the scale of the Analog I1 terminals.
Sleep Frequency	As Hz. This parameter value is <u>added</u> to the frequency set by the parameter MINIMUM FREQ . The combined value is the frequency at which drive will enter sleep mode when GPM is controlled at the set point.
Submersible Pump	ENABLE THIS FEATURE WITH SUMBERSIBLE PUMPS. Frequency will ramp from stop to the value set by parameter MIN FREQUENCY in one second. Submersible pumps suffer damage to the thrust bearing if operated below 30 Hz for more than 1 second.
Enable Restarts	Controls the ability of the drive to automatically restart after a fault.
Disable Manual Mode	Disables manual operation of the drive through the keypad.
Overcurrent Limit	Setting for motor overload protection, Trip Class 10 curve.

Table 13 – Pump Down Setup Wizard

PROMPT	DESCRIPTION
Run Pump Down Setup Wizard?	Press the “Enter” key to go through the wizard. Press “Home” key to return to Home screen.
Ft Measurement Multiplier	This value allows the Ft SETPOINT 1 to be increased by a factor of 10 or a factor of 100. If the Ft SETPOINT 1 is set to 20 ft, you can increase it to 200 ft or 2,000 ft by increasing this parameter.
4-20 mA Ft Sensor Range	This is the maximum value of the sensor being used.
Ft Setpoint 1	The height, in feet, that the drive will attempt to maintain.
Sleep Draw Down Level	This value is <u>subtracted</u> from the value Ft SETPOINT 1 . The resulting height is the value when the drive will stop the motor load at and enter sleep mode.
Ft Measurement Offset	This is used to calibrate the height that the VFD registers from transducer if a manual height measurement is not equal to VFD reading.
Wake Up Well Recovery	This value is <u>added</u> to Ft SETPOINT 1 . The combined value is the height when the VFD will start the motor load again.
Analog I1 Inverted	Inverts the scale of the Analog I1 terminals.
Sleep Frequency	As Hz. This parameter value is <u>added</u> to the frequency set by the parameter MINIMUM FREQ . The combined value is the frequency at which drive will enter sleep mode when GPM is controlled at the set point.
Submersible Pump	ENABLE THIS FEATURE WITH SUMBERSIBLE PUMPS. Frequency will ramp from stop to the value set by parameter MIN FREQUENCY in one second. Submersible pumps suffer damage to the thrust bearing if operated below 30 Hz for more than 1 second.
Enable Restarts	Controls the ability of the drive to automatically restart after a fault.
Disable Manual Mode	Disables manual operation of the drive through the keypad.
Overcurrent Limit	Setting for motor overload protection, Trip Class 10 curve.

Table 14 – Suction Pump Setup Wizard

PROMPT	DESCRIPTION
Run Suction Pump Setup Wizard?	Press the “Enter” key to go through the wizard. Press “Home” key to return to Home screen.
Suction Pressure Level	In psi. Used only for transducers wired to 1_2. The pressure setting where any value lower will trigger a fault.
Suction Pressure Time	In seconds. The time at which the pressure must remain below SUCTION PRESSURE LEVEL before triggering a fault.
Suction Pressure 4-20 mA Sensor Range	This value should be set to the maximum value of the 4-20 mA transducer being used for suction pressure control. i.e. if the transducer has a range of 0-150 psi, the parameter should be set to 150.
Analog I2 Inverted	Inverts the scale of the Analog I2 terminals.

4 ADJUSTABLE PARAMETERS

4.1 Changing Parameter Values



WARNING: When the drive is set to automatically restart after a fault, the output terminals can energize and the load can start without warning, exposing the user to risk of serious injury. Make certain the input is de-energized before approaching the equipment. The factory default setting does not allow automatic restarts. Use caution if automatic restarts are enabled.

The Change Parameter Values function allows the user to set values for a variety of functions including motor overload settings, number of restarts after a fault, and more. To change parameter values:

1. Press the HOME key until **CHANGE PARAMETER VALUES** appears on the display.
2. Press ENTER to access this menu item.
3. Use the UP and DOWN arrows to scroll through the sub-menu to find the item desired, then press ENTER. See **Table 15** through Error! Reference source not found. for a list of parameters.
4. Use the UP and DOWN arrow keys to scroll to the desired parameter, press ENTER, then use the UP and DOWN arrows to change the value.
5. When the value you want appears on the display, press ENTER to set the value or BACK to cancel.

4.2 Restore Default Parameter Settings

To restore **ALL** adjustable parameters (except for **REVERSE ROTATION, USER PASSWORD, and SWITCHING FREQUENCY**) to their default value, press and hold the BACK and ENTER keys at once and hold for three seconds. If a User Password is configured, you will first be prompted to enter the Password. You will then be prompted to press ENTER for yes or BACK for no.

IMPORTANT: Make certain the motor is stopped before resetting.



CAUTION: To reset an individual parameter to its default value, you must refer to the appropriate table of Adjustable Parameters, find the default value, re-enter that value and save it. See **Table 15** - Error! Reference source not found. for a complete list of parameters, their description, and default/minimum/maximum values.

4.3 Auto Restarts

The drive can be programmed to automatically restart after certain faults. Using the Auto Restart Parameters (**Table 16**), you can set a time delay before the drive starts after a fault and select the number of automatic restarts allowed before the unit will remain OFF after a fault.

Example: You wish to allow 10 automatic restarts after a **Dry Well Fault** but want the drive to wait for one hour, to allow the well to recover, before restarting. When the drive is counting down the time to restart after a fault, the display will indicate the time until restart in seconds.



Programming Tip

To interrupt the countdown and allow a restart, push and hold both the UP and DOWN keys for one second. The load will start immediately.

When the drive reaches the limit of faults set by the adjustable parameter, it will remain OFF and the display will indicate the type of fault on the top line. The second line will read **RESTART? ENTER**. Press ENTER to clear the fault and restart the load. The fault counters in the Restart Log will all be reset to zero. See **Section 3.6** for more information. Some faults do not allow auto restart. The display will read **NO AUTO RESTART**. See **Section 3.7, Fault Log**, for more information.

4.4 All Parameters List

To aid in troubleshooting, a numbered parameter list containing all parameters is available for use. Some parameters are visible that are not always used. In this case, the word “Disabled” is shown, and programming functionality is disabled for that parameter.

4.5 Changed Parameter List

This is a list of all parameters that have been changed from their default values. This allows for quick and easy programming of previously changed parameter values. The total number of changed parameters and the index of changed parameters will be displayed at the top of the screen. If there are no changed parameters, then “No Changed Parameters” will be shown.

Table 15 – Operating Parameters

DISPLAY MESSAGE	DESCRIPTION	DEFAULT/MIN /MAX VALUE
Output Voltage	Output voltage on main motor terminals and AUX POWER™ auxiliary output terminals, if applicable.	Default: System Specific/180/530
Min Frequency	Minimum output frequency allowed except during startup ramp. When SUBMERSIBLE PUMP parameter is enabled, frequency will ramp from stop to minimum frequency in one second. Important in protecting thrust bearing in submersible pumps.	30/5/120
Max Frequency	Maximum frequency allowed, or target frequency at start-up ramp. This value cannot be lower than MINIMUM FREQ.	60/5/300
Start Up Ramp Time	Time in seconds from MIN FREQUENCY to MAX FREQUENCY . Ramp speed is linear.	12/1/120

Overcurrent Limit	Setting for motor overload protection, Trip Class 10 curve.	240 V Output	480 V Output
		5 HP: 18/3/22 7 HP: 27/3/32 10 HP: 37/3/38 15 HP: 46/3/48 20 HP: 61/3/66 25 HP: 76/3/78 30 HP: 92/3/96	5 HP: 10/3/11 7 HP: 13/3/13 10 HP: 18/3/22 15 HP: 24/3/26 20 HP: 30/3/32 25 HP: 38/3/46 30 HP: 46/3/48 40 HP: 61/3/66 50 HP: 76/3/78 60 HP: 92/3/96 75 HP: 107/3/112 100 HP: 142/3/145 125 HP: 172/3/178 150 HP: 198/3/200 200 HP: 264/3/268 250 HP: 304/3/313 300 HP: 362/3/372 350 HP: 415/3/427 400 HP: 478/3/530 450 HP: 515/3/530 500 HP: 590/3/607
Dry Well Current	Unit shuts down when output current goes below the set value (dry well protection). To use this function for dry well protection, make certain the parameter DRY WELL KW is set at zero. Note: DRY WELL KW is an alternative method for detecting dry well conditions that measures power instead of current and in some cases may be more accurate. Drive must be stopped to adjust this value. Max Freq. must be greater than 57 Hz to engage Dry Well Current setting.	240 V Output	480 V Output
		5 HP: 0/0/20 7 HP: 0/0/26 10 HP: 0/0/30 15 HP: 0/0/46 20 HP: 0/0/61 25 HP: 0/0/76 30 HP: 0/0/92	5 HP: 0/0/10 7 HP: 0/0/14 10 HP: 0/0/20 15 HP: 0/0/26 20 HP: 0/0/30 25 HP: 0/0/38 30 HP: 0/0/46 40 HP: 0/0/61 50 HP: 0/0/76 60 HP: 0/0/92 75 HP: 0/0/107 100 HP: 0/0/142 125 HP: 0/0/172 150 HP: 0/0/198 200 HP: 0/0/264 250 HP: 0/0/304 300 HP: 0/0/362 350 HP: 0/0/415 400 HP: 0/0/478 450 HP: 0/0/515 500 HP: 0/0/590
Current Unbalance	% current unbalance allowed on output phases. NEMA MG1	80/1/100	

		240 V Output	480 V Output
Dry Well kW	<p>Unit shuts down when output, measured in kW, goes below the set value (dry well protection). To use this function for dry well protection, make certain the parameter DRY WELL CURRENT is set at zero.</p> <p>Drive must be stopped to adjust this value.</p>	<p>5 HP: 0/0/8 7 HP: 0/0/11 10 HP: 0/0/15 15 HP: 0/0/22 20 HP: 0/0/30 25 HP: 0/0/38 30 HP: 0/0/45</p>	<p>5 HP: 0/0/4 7 HP: 0/0/6 10 HP: 0/0/8 15 HP: 0/0/11 20 HP: 0/0/15 25 HP: 0/0/19 30 HP: 0/0/22 40 HP: 0/0/30 50 HP: 0/0/38 60 HP: 0/0/45 75 HP: 0/0/56 100 HP: 0/0/75 125 HP: 0/0/94 150 HP: 0/0/112 200 HP: 0/0/150 250 HP: 0/0/185 300 HP: 0/0/220 350 HP: 0/0/260 400 HP: 0/0/299 450 HP: 0/0/336 500 HP: 0/0/372</p>
Switching Frequency	Switching frequency of the IGBT inverter module. Range varies based on the rated HP of the drive.		<p>5-100 HP: 4k/2k/5k 125-500 HP: 2k/2k/5k</p>
Coast to Stop	Selects between coast to stop or ramp to stop. Ramp profile is controlled by parameter SHUTDOWN RAMP . NO = ramp to stop, YES = coast to stop		Default: Yes
GND Fault Detect Fault Sensitivity	Detects fault between any output line and earth. Sensitivity to fault detection is adjustable to avoid nuisance trips. Lower value equals lower sensitivity to fault detection.		Disabled/1/9
Submersible Pump	<p>ENABLE THIS FEATURE WITH SUMBERSIBLE PUMPS. Frequency will ramp from stop to the value set by parameter MIN FREQUENCY in one second. Submersible pumps suffer damage to the thrust bearing if operated below 30 Hz for more than 1 second. YES = one second ramp time from stop to minimum frequency NO = linear ramp time from stop to maximum frequency. Minimum frequency is still observed while the motor is running.</p>		Default: Yes
Reverse Rotation	Reverses motor direction by changing sequence of output phase rotation.		Standard ABC / Reverse ACB
Shutdown Ramp Time	Time in seconds from MAX FREQUENCY to MIN FREQUENCY . Ramp time is linear. Factory default setting enables the COAST TO STOP parameter which disables the SHUTDOWN RAMP parameter.		5/1/120
Overcurrent Derate Enable	Drive frequency will slow down to avoid motor overcurrent fault. Frequency will not go below MIN DERATE FREQUENCY . Screen will indicate OVERCURRENT DERATE when conditions apply.		Default: Yes
Over Temp Derate Enable	Drive frequency will slow down to avoid drive over temperature fault. Frequency will not go below MIN DERATE FREQUENCY . Screen will indicate OVER TEMP DERATE when conditions apply.		Default: Yes

Minimum Derate Frequency	Output frequency will not go below this value when derating.	45/30/60
PWM Over Modulation (DX Models only)	Output voltage may be lower than the input voltage because of losses from the sine wave filter or input reactor. Monitor output voltage and use this parameter to boost if necessary.	0/0/25
V/F Controls	Press Enter to access the following V/F parameters:	
V/F Selection	<p>Controls the relationship between voltage and frequency when starting a motor for different applications.</p> <p>Standard: Voltage and frequency are proportional. Torque is constant.</p> <p>Soft Start 1: Limits voltage during initial ramp to reduce inrush current. Torque is reduced.</p> <p>Soft Start 2: Exaggerated Soft Start ramp to reduce inrush current and torque more than Soft Start 1.</p> <p>Soft Start 3: Exaggerated Soft Start ramp to reduce inrush current and torque more than Soft Start 2.</p> <p>Torque Boost: Boosts voltage during initial ramp to increase startup torque.</p> <p>Profile Select: When this selection is chosen, the ramp profile can be customized based on the four V/F settings below.</p>	Default: Standard
V/F Mid Voltage		240 V: 120/0/240 480V: 240/0/480
V/F Min Voltage		240 V: 30/0/240 480 V: 60/0/480
V/F Mid Frequency		30/3/55
V/F Min Frequency		15/3/55
Pivot Overcurrent (1LH AUX Power models only)		Class 10 motor overload protection on the auxiliary output, AUX POWER™.

Table 16 – Auto Restart Parameters

DISPLAY MESSAGE	DESCRIPTION	DEFAULT/MIN /MAX VALUE
Enable Restarts	Controls the ability of the drive to automatically restart after a fault. NO = no auto restarts and unit will initialize in OFF mode YES = Auto mode on initialization and auto restarts allowed	Default: No
Dry Well Delay	Time in seconds dry well is allowed before unit trips	4/0/9999
Restart Delay 1	Delay in seconds before unit restarts after a trip due to: <ul style="list-style-type: none"> • CLASS 10 OVERLOAD • OVER CURRENT IN • SYSTEM CURRENT OVERLOAD 	60/0/9999
Restart Delay 2	Delay in seconds before unit restarts after a trip due to: <ul style="list-style-type: none"> • BUS OVERVOLTAGE • DRY WELL CURRENT • CURRENT UNBALANCE • DRY WELL KW 	15/0/9999
Restart Delay 3	Delay in seconds before unit restarts after a trip due to: <ul style="list-style-type: none"> • HALL SENSE HIGH • LOW INPUT VOLT • HIGH INPUT VOLT 	15/0/9999
Restarts Motor Overload	Number of automatic restarts allowed due to overload current trip on the load and line module	4/0/9999
Restarts Dry Well	Number of automatic restarts allowed due to under current and minimum power trip	10/0/9999
Restarts Current Imbalance	Number of automatic restarts allowed due to current imbalance trip	10/0/9999
Restarts Undervoltage	Number of automatic restarts allowed due to low input voltage trip	10/0/9999
Restarts Overvoltage	Number of automatic restarts allowed due to high input voltage trip	10/0/9999
Restarts Bus Overvoltage	Number of automatic restarts allowed due to DC bus overvoltage	10/0/9999
Startup Delay	Delay (in sec.) before a restart after an input power OFF/ON cycle.	0/0/9999
Restarts 1Ph V	Number of automatic restarts allowed due to loss of phase on input	10/0/9999
Restarts Sensor Conn Fail	Number of automatic restarts allowed due to loss of 4-20mA analog input signal	10/0/9999
Short Cycle Delay	Delay, in seconds, before motor starts after a RUN command. Prevents the drive from engaging the motor when it is spooling down during coast-to-stop operation. Delay affects both manual RUN command and RUN command from external signal in auto mode. Display will count down seconds until RUN.	3/0/300
Sensor Connection Fault Delay	Delay in seconds when the 4-20mA signal is lost before Sensor Conn Fail fault is triggered.	10/0/9999
Restarts System Current Overload	Number of automatic restarts allowed due to an Input or Output Overload fault.	0/0/9999
Startups Per Cycle	Number of startup sequence attempts the drive will perform after power is cycled, before requiring power to be cycled again.	0/0/10
Max Cycle Time	Maximum amount of time the drive will attempt to perform the startup sequence before requiring power to be cycled again.	1hr/0/7 days

Table 17 – Interface Parameters

DISPLAY MESSAGE	DESCRIPTION	DEFAULT/MIN /MAX VALUE															
<p>System Config (see Section 5.5, System Configuration for detailed information)</p>	<p>Sets the system configuration. 0 = ON/OFF control using AUX1 and AUX2. Both AUX1 and AUX2 must have a contact closure to run. By default, jumper wires will be installed, closing AUX1 and AUX2. 1= Digital Constant Pressure control. 2 = Analog Constant Pressure control. 3 = Analog Constant Pressure with redundant sensors and up to four psi setpoints. Control setpoint will change based on the states of AUX3 and AUX4. See table below.</p> <table border="1" data-bbox="491 467 840 597"> <thead> <tr> <th>AUX3</th> <th>AUX4</th> <th>Psi Setpoint</th> </tr> </thead> <tbody> <tr> <td>Open</td> <td>Open</td> <td>1</td> </tr> <tr> <td>Closed</td> <td>Open</td> <td>2</td> </tr> <tr> <td>Open</td> <td>Closed</td> <td>3</td> </tr> <tr> <td>Closed</td> <td>Closed</td> <td>4</td> </tr> </tbody> </table> <p>4 = Analog Constant Pressure with dual sensors and two psi setpoints. Control setpoint will change based on the states of AUX3 and AUX4. 5 = Speed control proportional to 0-5VDC analog signal (speed potentiometer). 6 = Speed control proportional to 4-20mA analog signal. 7 = Analog constant pressure (4-20 mA only) with HOA switch and motor speed control by potentiometer.</p> <p>See Section 5.5, on page 47, for more details.</p>	AUX3	AUX4	Psi Setpoint	Open	Open	1	Closed	Open	2	Open	Closed	3	Closed	Closed	4	<p align="center">0/0/7</p>
AUX3	AUX4	Psi Setpoint															
Open	Open	1															
Closed	Open	2															
Open	Closed	3															
Closed	Closed	4															
<p>Troubleshooting</p>	<p>Factory assisted use only. Contact manufacturer.</p>	<p align="center">0/0/5</p>															
<p>Password Setup</p>	<p>Allows keypad function to be password protected. When keypad is locked, it will prompt for a user-defined four-digit password. A parameter value of "0000" disables password protection. Each digit can go from 0 to F: 0, 1, 2, 3, 4, 5, 6, 7, 8, 9, A, B, C, D, E, F. Press enter to select the next digit.</p>	<p align="center">0000/0000/FFFF</p>															
<p>Program Relay No. 1</p>	<p>Programmable normally open / normally closed relay. Control Terminals COM, 1NC, 1NO. The relay can be programmed to change state for the following conditions: 0 = System Fault: State will change when drive faults. 1 = Reserved 2= Reserved 3 = Reserved 4 = Pump Fault e.g. motor overload, dry well, etc. 5 = Minimum Frequency. Relay changes state when motor frequency is greater than the value set by parameter MIN FREQUENCY. (see Note 1 at end of table) When lead/lag pump control has been selected, it will override programmable Relays 1,2,3 and 4. 6 = Jockey Pump. Relay will not participate in lead/lag or multiplex pump control. Instead, relay will change states when motor frequency is greater than 0, and open when it is exactly 0. This setting is only available for Relay 1.</p>	<p align="center">0/0/6</p>															

DISPLAY MESSAGE	DESCRIPTION	DEFAULT/MIN /MAX VALUE
Program Relay No. 2	Programmable normally open / normally closed relay. Control Terminals COM, 2NC, 2NO. The relay can be programmed to change state for the following conditions: 0 = System Fault; State will change when drive faults. 1 – 3 = Reserved 4 = Pump Fault e.g. motor overload, dry well, etc. 5 = Minimum Frequency. Relay changes state when motor frequency is greater than the value set by parameter MIN FREQUENCY . (see Note 1 at end of table) When lead/lag pump control has been selected, it will override programmable Relays 1,2,3 and 4.	0/0/5
Program Relay No. 3	Programmable normally open relay. Control Terminals 3NO, 3C. See Parameter PROGRAM RLY 2 above for description of values. Only available on Performance Series drives.	0/0/5
Program Relay No. 4	Programmable normally open relay. Control Terminal 4NO, 4C. See Parameter PROGRAM RLY 2 above for description of values. Only available on Performance Series drives.	0/0/5
Modbus Config	Press ENTER to see the following parameters related to Modbus.	
Modbus ID	Address of the drive for a modbus network.	1/0/1000
Modbus Wiring	Select between using 2-wire or 4-wire Modbus configuration.	Default: 4-wire
Modbus Stop Bits	Number of bits transmitted after each character to detect the end of the character.	1/1/2
Modbus Parity	Sets how the parity bit of the character's data frame is set.	None/Odd/Even
Modbus Data Rate	Serial baud rate or the rate at which information is transferred.	19200/4800/19200
Disable Manual Mode	Disables manual operation of the drive through the keypad. Operating states are limited to AUTO and OFF. YES = MANUAL mode disabled	Default: No
AUX1 Select	Programmable digital inputs. Generally used for motor Run/Stop control. 0 = RUN/STOP (closed = RUN, open = STOP) 1 = Always in RUN mode (no jumper or switch required) 2 = Latching relay. When the connection between the AUX terminal and COM is opened the drive will stop the motor and display a fault on the screen. The motor will remain stopped even if the connection is closed. The fault must be cleared by pressing the ENTER key. 3 = Function Disabled for AUX1. 4 = Reverse Latching Relay. When the connection between the AUX terminal and COM is closed the drive will stop the motor and display a fault on the screen. The motor will remain stopped even if the connection is opened. The fault must be cleared by pressing the ENTER key. 5 = Reset Drive Fault. AUX1 can be opened and closed to act as a manual reset for non-resettable faults. Function of these inputs can change when certain System Configuration settings are chosen. See Section 5.5 .	0/0/2 0/0/2

DISPLAY MESSAGE	DESCRIPTION	DEFAULT/MIN /MAX VALUE
AUX2 Select AUX3 Select AUX4 Select (AUX3 and AUX4 are not available on all drives in the series)	<p>Programmable digital inputs. Generally used for motor Run/Stop control.</p> <p>0= RUN/STOP (closed = RUN, open = STOP) 1= Always in RUN mode (no jumper or switch required) 2= Latching relay. When the connection between the AUX terminal and COM is opened the drive will stop the motor and display a fault on the screen. The motor will remain stopped even if the connection is closed. The fault must be cleared by pressing the ENTER key. 3=Reverse Rotation. When the circuit closes the motor will reverse rotation. 4= Reverse Latching Relay. When the connection between the AUX terminal and COM is closed the drive will stop the motor and display a fault on the screen. The motor will remain stopped even if the connection is opened. The fault must be cleared by pressing the ENTER key. 5 = Reset Drive Fault. AUX1 can be opened and closed to act as a manual reset for non-resettable faults.</p> <p>Function of these inputs can change when certain System Configuration settings are chosen. See Section 5.5.</p>	1/0/4 1/0/4
RTC Setup	<p>Real-Time Clock 022421 20:58:46 MO/DD/YR H:M:SS Enter button moves the character to the right, use UP and DOWN keys to select the number.</p>	Date and Time
LCD Contrast	Used to adjust the contrast of the graphic display.	40/30/59
Enable Scheduler	Allows commands to be scheduled for future deployment.	Default: No
Edit Schedule	Used to add, remove, or edit time stamps to schedule commands. Use the UP and DOWN arrows to change the current value, then use the ENTER and BACK buttons as left and right arrows to select the value being edited.	-

Note 1: This setting is typically used to control ancillary equipment in concert with motor RUN/STOP commands. *For example*, to control a chlorinator so that it operates only when the motor is pumping water.

Table 18 – Constant Pressure Parameters

 **Programming Tip**

Constant pressure parameters are only displayed when System Configuration has been set for constant pressure. The parameter **SYSTEM CONFIG** is in the Interface Parameters sub-menu. See **Table 17 – Interface Parameters** for details. Changing the parameter, **CONTROL METHOD**, will change the parameters that are visible, for instance, if **CONTROL METHOD** is set to **FLOW**, parameters associated with **CONSTANT PRESSURE** and **TANK LEVEL** control will not be displayed.

DISPLAY MESSAGE	DESCRIPTION	DEFAULT/MIN /MAX VALUE
Control Method	Select which variable(s) will be used to control the VFD: <ul style="list-style-type: none"> • Constant Pressure (psi) • Flow Control (GPM) • Tank Level Control (Ft) Each control method has its own setpoints, found later in the Constant Pressure Parameters menu.	Default: Constant Pressure
Broken Pipe FT	Dependent on Control Method selected. Psi, GPM, or Ft at which drive will determine there is a broken pipe. Value of zero disables this feature.	0/0/150
Broken Pipe Time	In minutes. Specifies the time that psi must remain below the value set by BROKEN PIPE PSI to trigger a fault.	0/0/9999
T OFF	In seconds. Used to prevent short cycling in CP systems. If the motor was off during the last cycle for a period greater than TOFF , the minimum on time of the motor is T1ON . If the motor was off for a period less than TOFF , the minimum on time of the motor is T2ON . Default values give a minimum cycle time of about 1 minute.	30/0/1000
T1 ON	In seconds. See T OFF above. Must be set to be less than T2ON .	15/0/1000
T2 ON	In seconds. See T OFF above. Must be set to be less than T2ON .	60/0/1000
Sleep Frequency (Previously Shutoff Frequency)	As Hz. This parameter value is <u>added</u> to the frequency set by MINIMUM FREQ (Table 15) . The combined value is the frequency at which drive will enter sleep mode when pressure is controlled at the set point.	7/0/300
Boost Amount	As a % of MAX FREQUENCY for digital CP systems, or as psi for analog CP systems. In digital CP systems, this increases motor speed by the % of the parameter value, for a specified time before the motor shuts down in sleep mode. In analog CP systems the parameter value specifies a pressure increase in psi before sleep mode.	-
Boost Time	In seconds. Length of time the drive will increase motor speed based on the parameter BOOST AMOUNT before entering sleep mode.	3/0/300
Precharge Frequency	In Hz. Sets the maximum frequency applied to the motor during the pre-charge interval.	30/1/120
Precharge Time	In seconds. Sets the maximum time for pre-charge regardless of any sensor inputs. A setting of zero disables the pre-charge mode.	0/0/30000
Precharge psi	Used only for analog CP systems. Pre-charge will be terminated when pressure reaches this set point. Should be set less than psi SETPOINT .	20/0/200
Sleep psi (Previously Overpressure psi)	This value is <u>added</u> to the value set by parameter psi SETPOINT . The combined value is the pressure at which drive will stop the motor load. Motor will restart when the pressure falls to the value set by parameter WAKE UP PSI .	20/0/500

DISPLAY MESSAGE	DESCRIPTION	DEFAULT/MIN /MAX VALUE
Sleep Flow	This value is <u>added</u> to the value set by parameter GPM SETPOINT 1 . The combined value is the flow rate at which drive will stop the motor load. Motor will restart when the pressure falls to the value set by parameter WAKE UP FLOW .	100/0/1000
Sleep Height	This value is <u>added</u> to the value set by parameter FT SETPOINT 1 . The combined value is the flow rate at which drive will stop the motor load. Motor will restart when the pressure falls to the value set by parameter WAKE UP HEIGHT .	3/0/50
Flow Rate Limit	This value is added to the GPM SETPOINT to set the flow rate value at which the drive will stop the motor load.	10/1/320
Tank Full Limit	This value is added to the FT SETPOINT to set the tank level value at which the drive will stop the motor load.	2/0/50
GPM Measurement Multiplier	This value allows the GPM SETPOINT 1 to be increased by a factor of 10 or a factor of 100. If the GPM SETPOINT 1 is set to 20 GPM, you can increase it to 200 GPM or 2,000 GPM by increasing this parameter.	20/20/2000
Ft Measurement Multiplier	This value allows the FT SETPOINT 1 to be increased by a factor of 10 or a factor of 100. If the FT SETPOINT 1 is set to 20 ft, you can increase it to 200 ft or 2,000 ft by increasing this parameter.	5/5/5000
Duplex Cycle Time	In hours and minutes. Determines the run time for each cycle of both primary and secondary pump	0/0/9999 hours
Wake Up psi (Previously Draw Down psi)	As psi. Provides hysteresis during sleep mode. Controls the pressure drop below psi SETPOINT to start motor in sleep mode, e.g. if WAKE UP psi = 5 and motor turns off at 50 psi, motor will restart at 45 psi.	5/0/50
Wake Up Flow	As GPM. Provides hysteresis during sleep mode. Controls the flow drop below GPM SETPOINT 1 to start motor in sleep mode, e.g. if WAKE UP FLOW = 5 and motor turns off at 50 GPM, motor will restart at 45 GPM.	100/0/1000
Wake Up Height	As feet. Provides hysteresis during sleep mode. Controls the height drop below FT SETPOINT 1 to start motor in sleep mode, e.g. if WAKE UP HEIGHT = 5 and motor turns off at 50 ft, motor will restart at 45 ft.	1/0/50
4-20mA psi Sensor Range	This value should be set to the maximum value of the 4-20 mA pressure transducer being used for constant pressure control. i.e. if the transducer has a range of 0-150 psi, the parameter should be set to 150. This parameter is critical for accurate pressure control.	150/50/500
4-20 mA Ft Sensor Range	In feet. This value should be set to the maximum value of the 4-20 mA tank level sensor being used for constant pressure control. i.e. if the sensor has a range of 0-10 feet the parameter should be set to 10.	10/0/40
4-20 mA GPM Sensor Range	This value should be set to the maximum value of the 4-20 mA flow meter being used for constant pressure control. i.e. if the flow meter has a range of 0-300 GPM the parameter should be set to 300.	40/1/320

Sensor Offsets	Press ENTER to see the following three offset parameters.	
psi Measurement Offset	This is used to calibrate the pressure that the VFD registers from pressure transducer if a manual pressure measurement is not equal to what VFD is reading. For instance, if VFD reads 40 psi, but manual measurement shows 50 psi, this setting should be set to +10.	0/-50/+50
GPM Measurement Offset	This is used to calibrate the flow that the VFD registers from flow meter if a manual measurement is not equal to what VFD is reading. For instance, if VFD reads 40 GPM, but manual measurement shows 50 GPM, this setting should be set to +10.	0/-50/+50
Ft Measurement Offset	This is used to calibrate the tank level that the VFD registers from tank level sensor if a manual measurement is not equal to what VFD is reading. For instance, if VFD reads 2 ft, but manual measurement shows 5 GPM, this setting should be set to +3.	0/-50/+50
Control Setpoints	Press ENTER to access the following setpoint parameters. Parameters will vary based on model, system config, and control method.	
psi Setpoint 1	In psi. For analog CP systems only. This sets the level at which the pressure will be controlled. Must be set as a psi value within the range of the 4-20 mA transducer. Make sure the value of the parameter 4-20mA psi RANGE is set to the maximum psi value of the sensor you are using. Up to four psi set points can be used depending upon the System Configuration.	50/0/500
psi Setpoint 2		0/0/200
psi Setpoint 3		0/0/200
psi Setpoint 4		0/0/200
GPM Setpoint 1	In GPM. For analog CP systems only. This sets the level at which the flow will be controlled. Must be set as a GPM value within the range of the flow meter. Make sure the value of the parameter 4-20mA GPM SENSOR RANGE is set to the maximum GPM value of the sensor you are using. Up to four GPM set points can be used depending upon the System Configuration.	20/10/320
GPM Setpoint 2		20/10/320
GPM Setpoint 3		20/10/320
GPM Setpoint 4		20/10/320
Ft Setpoint 1	In feet. For analog CP systems only. This sets the value at which the tank level will be controlled. Must be set as a value within the range of the tank level sensor. Make sure the value of the parameter 4-20mA Ft SENSOR RANGE is set to the maximum value of the sensor you are using. Up to four tank level set points can be used depending upon the System Configuration.	5/0.5/50
Ft Setpoint 2		5/0.5/50
Ft Setpoint 3		5/0.5/50
Ft Setpoint 4		5/0.5/50
Suction Pump Config	Press ENTER to access the following Suction Pressure settings. Transducer must be wired into I_2 for Suction Pressure control.	
Suction Pressure Level	In psi. Used only for transducers wired to I_2. The pressure setting where any value lower will trigger a fault.	0/0/200
Suction Pressure Time	In seconds. The time at which the pressure must remain below SUCTION PRESSURE LEVEL before triggering a fault.	0/0/18000
Suction Pressure 4-20 mA Range	This value should be set to the maximum value of the 4-20 mA transducer being used for suction pressure control. i.e. if the transducer has a range of 0-150 psi, the parameter should be set to 150.	150/30/500
Analog I2 Inverted	Reverses the scale of the I_2 analog signal. Can also be found under PID Control Parameters.	Default: No

Note 1: The restart counter must be cleared to begin counting the number of restarts from zero. Main Menu item, Clear Memory, resets the fault counters. See **Section 3.2, Keypad Main Menu Items**, for more information.

Note 2: Push the up-arrow key and down arrow key simultaneously to interrupt the countdown delay and allow an auto restart.

Table 19 – Lead/Lag Parameters

 **Programming Tip**

Lead/Lag parameters are only displayed when System Configuration has been set for constant pressure. The parameter **SYSTEM CONFIG** is in the Interface Parameters sub-menu. See **Table 17** and **Section 5.5**, for details. More information on can also be found in **Section 6.6**.

DISPLAY MESSAGE	DESCRIPTION	DEFAULT/MIN /MAX VALUE
Number Lag Pumps	Sets the number of auxiliary pumps that are connected to the relays on the control board. The relays will be called for in order, starting with Relay 1.	0/0/4
Stage Pump Delay	In Seconds. Delay before the system will call for a pump to be staged in.	4/0/3600
Destage Pump Delay	In Seconds. Delay before the system will de-stage a pump when pressure is maintained at MIN FREQUENCY of the primary pump.	4/0/3600
Stage Freq Reduction 1	In Hz. Reduces frequency of primary pump for the duration of the STAGE TIME when the specified pump is staged in.	Lag #1: 5/0/120
Stage Freq Reduction 2		Lag #2: 5/0/120
Stage Freq Reduction 3		Lag #3: 5/0/120
Stage Freq Reduction 4		Lag #4: 5/0/120
Stage Time	In Seconds. This is the interval for which the system will reduce its frequency by STAGE FREQ REDUCTION .	4/0/3600
Destage Freq Boost 1	In Hz. Increases frequency of primary pump for the duration of the DESTAGE TIME when the specified pump is de-staged.	Lag #1: 5/0/120
Destage Freq Boost 2		Lag #2: 5/0/120
Destage Freq Boost 3		Lag #3: 5/0/120
Destage Freq Boost 4		Lag #4: 5/0/120
Destage Time	In Seconds. This is the interval for which the system will increase its frequency by DESTAGE FREQ BOOST .	4/0/3600
Stage psi Lag	In psi. Allows the system to fall below the control psi by this amount before the system starts counting STAGE TIME . Assumes max Hz.	5/0/200
Destage psi Lag	In psi. Allows the system to exceed the control psi by this amount before the system starts counting DESTAGE TIME . Assumes min Hz.	3/0/200
Destage Min Freq	In Hz. MIN FREQUENCY of primary pump plus this amount to de-stage.	5/0/120
Precharge Pumps	Sets the number of auxiliary pumps that will assist the primary pump during a pre-charge interval. CAUTION! This number should never be greater that the total number of lag pumps as it will activate the associated programmable relay which may be used for other functions.	0/0/4

Table 20 – PID Control Parameters

DISPLAY MESSAGE	DESCRIPTION	DEFAULT/MIN /MAX VALUE
Analog Config	Press ENTER to access the following Analog parameters:	
Analog I1 Select	Sets function and status of the 4-20 mA input, I_1. 0 = I_1 ON 1 = I_2 ON 2 = I_1 ON, I_2 redundant 3 = I_2 ON, I_1 redundant	0/0/3
Analog I2 Select	Sets function and status of the 4-20 mA input, I_2. 0 = I_1 ON 1 = I_2 ON 2 = I_1 ON, I_2 redundant 3 = I_2 ON, I_1 redundant	0/0/3
Analog I1 Inverted	Reverses the scale of the I_1 analog signal.	Default: No
Analog I2 Inverted	Reverses the scale of the I_2 analog signal.	Default: No
Analog 5V Inverted	Reverses the scale of the 0-5 VDC signal.	Default: No
Proportional Gain	Multiplier for the analog error signal in an analog CP system. When parameter is set to zero, the keypad displays SIMPLE MODE and the controller switches to an algorithm which does not require a gain setting. When using PI control, best results will be obtained by starting with a value of 5.	5/0 (Simple Mode)/60
Integral Gain	Multiplier for the integral term in PI control of analog CP. Used to fine tune control of unstable systems. Parameter is disabled when PROPORTIONAL GAIN is set to SIMPLE MODE .	12/0/100
Derivative Gain	Used to reduce overshoot and oscillation. Should be used only when necessary because it tends to amplify noise in the transducer signal. It may cause the system to become unstable.	0/0/50
PID Filter Gain	Controls the rate of frequency increase in response to the error term.	0/0/100
PID Filter Time	In seconds. Sample interval for the PID Filter Gain.	1/0/10

5 OPERATION

5.1 Commissioning the Unit

It is always advisable to check the operating status of the drive and its load before commencing regular operation.

Initial Operation

Verify the following:

1. The unit is securely attached to the proper mounting surface.
2. The unit's input terminals are connected to an appropriate power source.
3. An appropriately rated motor is connected to the output terminals.
4. The motor is secured and properly mounted.

Setup Wizard

Upon the first initialization of the unit (or after restoring factory defaults of all parameters) the drive will prompt the user to select or decline a Setup Wizard. Setup Wizards allows users to quickly setup commonly used control schemes: Constant Pressure Control, Flow Control, Tank Level Control, Pump Down Control, and Suction Pump Control. The wizards will guide users through a list of commonly used parameters for the control method selected. Use the UP and DOWN keys to select which control method you would like to set up then press ENTER. If you would rather program the drive manually, press HOME to skip this step.

5.2 VFD Setup Procedure

1. If remote or automatic ON/OFF function is required, connect remote switch leads to the AUX1 and COM terminals. An additional remote switch or jumper wire may be connected to the AUX2 and COM terminals. The **AUX1 to COM and AUX2 to COM jumper wires will already be installed by the factory, remove as needed for pressure switches or remote ON/OFF switches.**
2. If a Constant Pressure (CP) water system will be operated, connect the pressure sensors to the appropriate Control Terminals. See **Section 5.5, System Configuration**, and **Section 6, Constant Pressure Systems** for details.
3. Apply power to the input terminals of the drive by turning on the input circuit breaker or disconnect switch.
4. The graphic display will scroll through several start-up sequence messages.
5. If the **ENABLE RESTARTS** parameter is set to allow restarts, the drive will initialize in AUTO mode and the motor will run when control signals call for a motor run condition. To prevent the motor from running at start-up, immediately after initialization, press the STOP/OFF key until **OFF** appears on the display or open AUX1 or AUX2.
6. Confirm that the unit has properly energized, and the display indicates the OFF mode.
7. Using the keypad and display, navigate to the Main Menu item, **CHANGE PARAMETER VAULES**, to set the following parameters for basic operation (see **Table 15 - Table 16** for details):

- **INTERFACE PARAMETERS > SYSTEM CONFIG** This parameter is critical to the operation of the system. The default setting is for simple ON/OFF operation. See **Section 5.5, System Configuration**, for complete information.
 - **OPERATING PARAMETERS > OVERCURRENT LIMIT** This parameter sets the motor overload protection. See **Section 5.4, Motor Overload Protection**, for complete information.
 - **AUTO RESTART PARAMETERS > ENABLE RESTARTS** This parameter enables the drive to initialize in AUTO mode and to restart automatically after a fault. Factory default does not allow auto restarts.
8. Push the MANUAL key until **MANUAL** appears on the display for manual mode, then push RUN to start the motor. In manual mode, the RUN key will override an open AUX terminal or other external control signal. Push the STOP key to stop the motor in manual mode.

 **CAUTION:** In manual mode, pushing the RUN key will override all external control signals, including constant pressure sensors. Dangerous pressure rise in closed plumbing systems is possible.
 9. The motor will start with the default acceleration ramp time of 0-30 Hz in one second, then 30-60 Hz in eight seconds.
 10. Confirm that the motor rotation is correct. Swapping any two of the output leads will reverse the motor rotation.
 11. After initial power-up, use the keypad and display to navigate to **CHANGE PARAMETER VALUES** to set any other adjustable parameters you wish to be different from the factory defaults.

5.3 Ground Fault Detection

These drives are equipped with a feature to detect a fault between any of the output lines and earth. If a ground fault is strong enough to trigger the parameter **GND FAULT DETECT**, the drive will not allow the IGBTs to switch. However, this does not protect the drive from damage in all situations. **If a ground fault occurs, immediately disconnect the input power!** Long motor leads and a dV/dt filter can cause nuisance indications of a ground fault. If a megger does not indicate a ground fault, the sensitivity of the ground fault detection may need to be reduced by reducing the value of parameter **GND FAULT DETECT**.

 **CAUTION:** Before the motor is connected to the output terminals, check all output lines for line-to-ground faults using a megger. There is a direct path through the drive circuitry for ground fault currents that can be triggered when power is applied to the input terminals, even though the output switches are not activated. These currents can cause serious damage to drive circuitry and are not covered under warranty.

 **WARNING!** The default operating mode when the unit is energized is OFF. If the parameter ENABLE RESTARTS has been set to allow restarts, the unit will energize in AUTO mode. If the external controls are calling for a motor run condition, the motor will start. Make sure either external controls are off before energizing the input, or as soon as the unit has initialized, push the STOP/OFF key until **OFF** appears on the display. Refer to **Section 3.1, Using the Keypad and Display**, for instructions on operating the keypad.

5.4 Motor Overload Protection

These drives are equipped with adjustable solid-state motor overload protection. Protection is based on a Class 10 trip curve. Motor overload settings are selected by navigating to the appropriate menu item using the keypad and display.

Thermal Memory and Thermal Memory Retention

The motor overload protection is equipped with thermal memory and thermal memory retention capabilities.

THERMAL MEMORY is the ability of an overload protective system to approximate the heating cooling of a protected motor during operation.

THERMAL MEMORY RETENTION maintains the thermal memory upon shutdown or power loss. This includes retention of the last thermal value and may include an ongoing reduction of this thermal value to reflect the cooling of the motor. This information will be used by the overload protective system to approximate the thermal state of the motor upon restart.

 **CAUTION:** Do not attempt to restart the motor immediately after a motor overload fault. The motor overload protection system uses a timer to approximate motor cooling and may trigger an immediate overload fault if the motor is restarted too soon.

If the drive loses power immediately after a motor overload fault, it will not begin counting down the time that approximates motor cooling until the drive is energized. If the drive faults with a motor overload, it may be necessary to allow time for this countdown before the motor is operated even though the motor has been off for an extended period.

Setting Motor Overload Protection with Keypad

To set motor overload protection with the keypad, navigate to the Main Menu item **CHANGE PARAMETER VALUES > CHANGE OPERATING PARAMETERS > OVERCURRENT LIMIT**.

5.5 System Configuration

The drive can operate several types of systems, including constant pressure water systems, and simple ON/OFF control from remote switches. **The correct system configuration must be selected for proper operation of the different types of control systems!**

System configuration is set by navigating to the keypad Main Menu item **CHANGE PARAMETER VALUES > CHANGE INTERFACE PARAMETERS > SYSTEM CONFIG**. Refer to **Section 4.1, Changing Parameter Values, Table 17, Interface Parameters**, for detailed instructions. Below is a brief description of each configuration setting:

- **System Configuration = 0: Basic RUN/STOP operation.** This is the factory default configuration for basic operation of the drive that allows RUN/STOP control of the motor in AUTO mode using a dry contact on AUX1 and/or AUX2. Both AUX1 and AUX2 must have a contact closure to run. AUX3 and AUX4 can be enabled if needed.

- **System Configuration = 1: Digital Constant Pressure.** Use this setting to operate digital constant pressure systems. Only use digital pressure switches purchased from or approved by Phase Technologies. Refer to **Section 6.3**, for more information on operating the drive in this mode.
- **System Configuration = 2: Basic Analog Constant Pressure.** Use this setting to operate analog constant pressure systems with a 4-20 mA transducer. Refer to **Section 6.4, Analog Constant Pressure Systems**, for more information on operating the drive in this mode. Refer to **Figure 13** for a diagram illustrating connection of the transducer to Control Terminals.
- **System Configuration = 3: Analog Constant Pressure with redundant sensors and up to four PSI Setpoints.** This configuration allows the use of two 4-20 mA transducers. The primary sensor is connected to the *I_1in+* and *I_1in-* Control Terminals, with the backup sensor connected to the *I_2in+* and *I_2in-* Control Terminals. If the primary sensor fails, the backup sensor will automatically take over control of constant pressure at the same settings.

Multiple control setpoints can also be used in this configuration. Enter the value of these setpoints in the Constant Pressure menu item, **CONTROL SETPOINTS**.

The table below shows what set point the system will follow based on the configuration of the AUX3 and AUX4 terminals. **Aux1 and AUX2 must also be closed for the system to run.**

Table 21 – System Configuration Setpoints

AUX3	AUX4	Psi Setpoint
Open	Open	1
Closed	Open	2
Open	Closed	3
Closed	Closed	4

System Configuration = 4: Analog Constant Pressure with dual sensors and two psi set points. In this configuration a 4-20 mA transducer connected to Control Terminals *I_1in+* and *I_1in-* controls pressure equal to the first setpoint (**psi1, GPM1, Ft1**), and a second sensor connected to the *I_2in+* and *I_2in-* Control Terminals controls pressure equal to the second setpoint (**psi2, GPM2, Ft2**). Enter the value of these set points in the Constant Pressure parameter, **CONTROL SETPOINTS**.

The digital input on Control Terminals AUX2 control selection of the different set points when the pump is operating. AUX1 functions as a RUN/STOP input where AUX1 closed = RUN, AUX1 open = STOP. The control scheme for the two psi set points is as follows:

1. If AUX2 is open the sensor on *I_1in* will be in control and set point will be equal to **psi1/FPM1/Ft1**, depending on which option is selected for **CONTROL METHOD**.
 2. If AUX2 is closed the sensor on *I_2in* will be in control and psi set point will be equal to **psi2/GPM2, Ft2**, depending on which option is selected for **CONTROL METHOD**.
- **System Configuration = 5: Speed control with 0-5VDC analog signal.** Use this setting for motor speed control by a potentiometer or an external 0-5 VDC source connected to the 0-5 VDC Control Terminals. Refer to **Figure 14** for a diagram illustrating connection of the potentiometer or the voltage source to Control Terminals. The drive will ignore the DC analog signal until it reaches a value proportional to the speed set by the parameter, **MIN FREQUENCY**, which has a factory default setting of 30 Hz. For speed control across the full-scale range of the analog signal, set **MIN**

FREQUENCY to the minimum value of 5 Hz. AUX1 and AUX2 must be closed to run in this System Configuration.

- **System Configuration = 6: Speed control with 4-20 mA analog signal.** Use this setting for motor speed control proportional to a 4-20 mA analog signal. The drive will ignore the analog signal until it reaches a value proportional to the speed set by the parameter, **MIN FREQUENCY**, which has a factory default setting of 30 Hz. For speed control across the full-scale range of the analog signal, set **MIN FREQUENCY** to the minimum value of 5 Hz. Refer to **Figure 13** for a diagram illustrating connection of the transducer to Control Terminals. When using an external 4-20 mA source, connect the leads to *L_{1in}*- and COM. AUX1 and AUX2 must be closed to run in this System Configuration.



CAUTION: This is not a constant pressure control mode. Motor speed will be controlled in a linear fashion proportional to the analog signal.

System Configuration = 7: Analog constant pressure with HOA and speed potentiometer. This setting allows the user to either turn the motor off, control motor speed with a potentiometer or operate in analog constant pressure mode using an HOA switch. Access to the keypad is not required to operate in this mode. A mechanical HOA switch changes the state of AUX1 and AUX3 Control Terminals to change to mode of operation in this configuration. A potentiometer is connected to the 0-5 VDC control Terminals, a 4-20 mA analog transducer is connected to the I+ and I- Control Terminals, and a double pole, triple throw HOA switch is connected to AUX1 and AUX3 Control Terminals.

- AUX1 controls for motor run and stop. When the switch is in the OFF position AUX1 is open and the motor will stop. When it is closed (either HAND or AUTO position) the motor will run. AUX3 toggles between analog constant pressure and motor speed control by the potentiometer. When the switch is in the AUTO position and AUX3 is open the drive will operate in analog constant pressure mode. When the switch is in the HAND position it is closed, and the potentiometer will control motor speed.
- Refer to **Figure 15** for a diagram illustrating connection of the transducer to Control Terminals. AUX2 must be closed to run in the Analog CP Mode (Auto), and AUX 2 is ignored when the speed potentiometer is used (Hand).

The System Configuration must be in any of the constant pressure modes to enable Pre-Charge of the plumbing system or Lead/Lag pump control. See **Section 6.5, Pre-Charge** and **Section 6.6, Lead/Lag Pump Control** for more information.

5.6 Start-Up and Shut-Down Ramp Times

Start-up and shut-down ramp times specify the time required to go from Minimum Frequency to Maximum Frequency or vice versa. Ramp times and profiles are adjustable by changing Operating Parameters through the keypad and text display. **The factory default setting for START UP RAMP** is 8 seconds and **SHUTDOWN RAMP** has been disabled through the **COAST TO STOP** parameter to reduce nuisance tripping from high inertia loads.

***SUBMERSIBLE PUMP* Parameter and Minimum Frequency**

Most submersible pump motor manufacturers require the motor to reach 30 Hz within one second to protect the pump from damage. The parameter, ***SUBMERSIBLE PUMP***, limits the time the motor runs below 30 Hz to one second.

When ***SUBMERSIBLE PUMP*** is set to YES, the motor speed will ramp to minimum frequency in one second, then ramp to the maximum frequency in a total of 8 seconds. The ramp times can be changed through the adjustable parameter, ***START UP RAMP***. The default ramp is shown in **Figure 17**. The factory default setting for ***SUBMERSIBLE PUMP*** is YES and for ***MIN FREQUENCY*** it is 30 Hz.

When the ***SUBMERSIBLE PUMP*** parameter is set to NO, the motor will ramp from stop to the maximum frequency in 8 seconds in a linear fashion as depicted in **Figure 18**.

To set the minimum frequency, navigate to the keypad Main Menu item, ***CHANGE PARAMETER VALUES > CHANGE OPERATING PARAMETERS > MIN FREQUENCY > 30 Hz***.

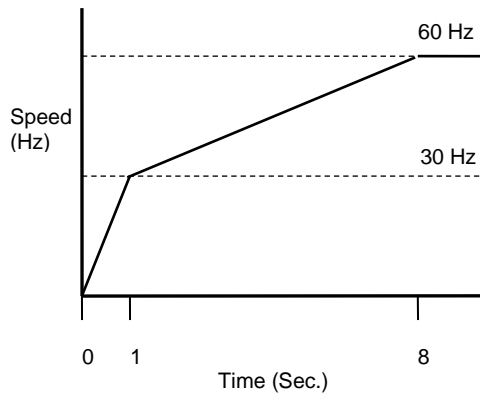

Figure 17 - Default Start-Up Ramp (***SUBMERSIBLE PUMP*** parameter enabled)

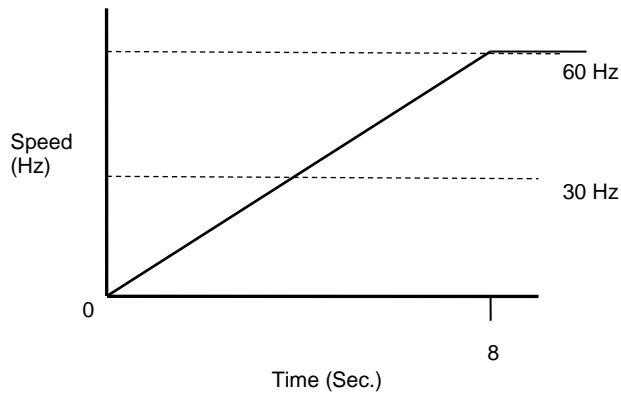

Figure 18 – Start-Up Ramp with ***SUBMERSIBLE PUMP*** parameter disabled



CAUTION: Most submersible pump motor manufacturers require the motor to reach 30 Hz within one second to protect the pump from damage. Factory default ramp time is 0-30 Hz in one second, followed by the selected ramp time from 30 Hz to maximum frequency.

5.7 Motor Control Methods (V/f vs. Torque Control Specific To V-Series Products)

Advanced motor control methods can be selected through Motor Control parameters found in Error! Reference source not found..

V/f Control

V/f, or volts per Hertz, control is the simplest motor control method and is the default operating mode of the drive. V/f control requires limited motor data to the drive and is the only control method that will allow multiple motors to be operated by one drive. If multiple motors are operated, they must all stop and start together.

Compared to open loop vector torque control, V/f control has limited starting torque. Even so, this method is adequate for most variable torque applications such as fans and pumps.

The simplicity of V/f control results in speed regulation approximately 2-3% of maximum frequency compared to about 0.2% for open loop vector control. Again, this level of speed regulation is adequate for most applications.

Open Loop Vector Control

Open loop vector control independently controls motor speed and torque much like DC motors. Compared to V/f control, the motor can develop higher torque at lower speeds. Open loop vector control has a quicker speed response for better control of dynamic loads and superior speed regulation when precise control is required.

It is important that accurate motor information is provided to the drive for open loop vector control. Be sure to enter the motor nameplate values for the parameters **Motor Rated Voltage**, **Motor Rated Current** and **Motor Rated RPM** when this mode is selected.

Torque Limit

This parameter allows the user to select a motor torque limit that is less than or greater than 100% of motor torque. Torque limits can be used to prevent damage to the motor and the loads it operates. This parameter is applicable for both motoring mode (positive torque) and regenerative mode (negative torque). The drive will reduce motor speed to avoid exceeding the torque limit.

Flux Reference

Torque is equal to flux times current. Flux reference to the motor is automatically calculated by the inverter using the motor parameters. Users can adjust the flux reference from 10% to 200% of the calculated flux reference. This parameter might be used when the drive experiences overcurrent trying to start a heavy load. At light loads, using the rated flux values decreases the efficiency of the drive. By using flux optimization, the efficiency of the drive increases when operating below rated load.

Flux reference can greatly affect the performance of the system. A flux reference that is too low results in smaller torque production in the motor with large stator currents. If flux reference is too higher, the result is high ripple in torque, large stator currents and low efficiency. Caution should be exercised when adjusting this parameter. Make changes in small increments and monitor motor performance.

6 CONSTANT PRESSURE SYSTEMS

LH and DX drives can be configured as constant pressure (CP) water systems using either an analog pressure transducer (analog constant pressure system) or pressure switches (digital constant pressure system). A CP water system includes a pressure tank, a pressure gauge to observe system pressure, and pressure switches or sensors.

6.1 Control Principles of Constant Pressure Systems

In a CP system, a target pressure for the system is set on the switch itself (digital CP) or through the keypad (analog CP). Signals from the sensors interact with firmware to control the motor speed and maintain constant water pressure.

In a strict definition of a constant pressure system, the pump would never turn off. If the pressure differential between pump-on and pump-off was zero, the noise fluctuations of the transducer output would cause the motor to cycle constantly between the on and off states. For this reason, most applications will want to accept a small differential pressure in the system to prevent either continuous running of the motor or constant on/off cycling of the motor.

Three basic conditions must be met for the pump to shut down and enter sleep mode:

1. The pressure in the system must be at the pressure control point set by the parameter **psi SETPOINT** or at the pressure determined by the setting on the digital pressure switch.
2. The frequency is below **SLEEP FREQUENCY** (as defined as **MIN FREQUENCY** + input value) or measured pressure is above **OVERPRESSURE psi** (as defined as **psi SETPOINT** + the input value).
3. The time expired since the pump started after the last OFF cycle must be greater than parameter **T1ON** or **T2ON**.

Preventing Short Cycling During Low Flow Conditions

When a CP system is in a low flow state, it may be desirable to turn the motor off (sleep mode) in order to conserve energy and preserve the motor. The adjustable parameters **TOFF**, **T1ON**, **T2ON**, **SLEEP FREQUENCY**, **SLEEP psi**, **WAKE UP PSI**, and **BOOST AMOUNT** control when the motor is turned off, how long it is off, and prevent short cycling of the motor at low flow rates. More information including default values for these parameters can be found in **Table 18**.

WAKE UP PSI and **BOOST AMOUNT**

The primary method to prevent short cycling is to allow a differential between the pressure at which the pump turns off and the pressure at which it restarts. Two parameters, **WAKE UP PSI** and **BOOST AMOUNT**, control this differential. **BOOST AMOUNT** specifies the increase in pressure above **psi SETPOINT** just before the pump shuts down to enter sleep mode, while **WAKE UP PSI** specifies the pressure drop below **psi SETPOINT** at which the pump restarts. For example, assume **psi SETPOINT** = 50, **BOOST AMOUNT** = 5, and **WAKE UP PSI** = 5. When the pump is ready to enter sleep mode, the pump will boost to 55 psi, then restart when the pressure falls to 45 psi. These two parameters can be used together or independently to create a dead band in pressure control. **SLEEP PSI** and **SLEEP FREQ** can also be set to tell the drive when to enter sleep mode. **SLEEP psi** (analog CP only) is the system pressure at which the drive will go to sleep. **SLEEP psi** is additional system protection in analog

CP. This is a value (entered) + the **psi SETPOINT**. The default value for **SLEEP psi** is 20. For example, if the **psi SETPOINT** is 50psi, the drive will stop if pressure reaches 70 psi.

Similarly, **SLEEP FREQUENCY** can be used to put the drive to sleep (for analog or digital constant pressure systems). **SLEEP FREQUENCY** is defined as a value (entered) + **MIN FREQUENCY**. As constant pressure is achieved and the drive slows down, the unit will go to sleep when **SLEEP FREQUENCY** is achieved. It is recommended that **WAKE UP psi** and **SLEEP FREQUENCY** values be entered when using digital or analog systems.

Digital CP systems cannot utilize the **WAKE UP PSI** parameter because the drive receives information from the sensor only when the pressure crosses the pressure set point of the digital sensor. Digital CP systems create a dead band in pressure by relying only on the **BOOST AMOUNT** parameter. Unlike analog systems that can measure pressure during the boost, digital systems rely on a specified increase in motor speed for a specified time to achieve a boost in pressure prior to sleep mode. When the System Configuration is set for Digital CP, the value for **BOOST AMOUNT** is equal to a per cent increase in maximum allowable motor speed for a specified time. For example, if **MAX FREQUENCY** = 60 and **BOOST AMOUNT** = 5, the motor speed will increase to 63 Hz ($60 \times (1+.05)$) for a time that varies based on boost amount. The user must observe an external pressure gauge to determine if this produces the desired boost amount.

ON/OFF Cycle Timers

The controls also record the length of time the motor remained in the OFF cycle and compare that time to the parameter, **TOFF**. If the motor-off time during the last OFF cycle was greater than the value of **TOFF**, then the minimum motor-on time will be equal to **T1ON**. If the motor-off time was less than **TOFF**, the minimum motor-on time will be equal to **T2ON**.

In other words, the time of the last OFF cycle determines whether the next ON cycle should be relatively long or relatively short. **Figure 19** demonstrates how the system adjusts the motor-on time in response to motor-off time.

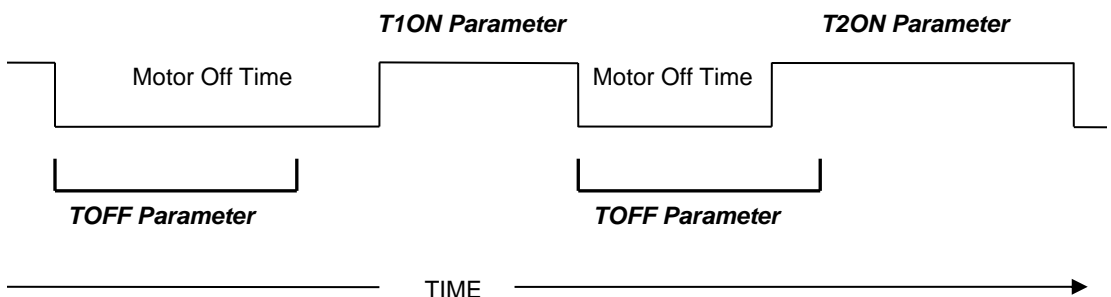

Figure 19 – Motor On and Motor Off Times

Fine Tuning with PI Control

PI control is not available when operating in Digital CP mode.

When operating in analog CP mode, if the parameter **PROPORTIONAL GAIN** is set to a value less than 1, the keypad displays **SIMPLE MODE** and the controller uses an algorithm that is not PI control. Simple Mode requires less fine tuning than PI control, but in some applications may not provide the control and stability desired. The stability of the constant pressure system (i.e., its tendency **not** to exhibit pressure oscillations) is determined by parameters set on the keypad, the flow rate of the pump, and the volume of the pressure tank. Stability of a system with a large maximum flow rate and a small pressure tank will be more difficult to control and may require de-tuning the system to accept larger variations in the system pressure and longer response times.

Analog constant pressure systems with PI (proportional integral) control provide more options to fine tune pressure control than digital constant pressure systems or analog systems in Simple Mode. Systems that are not adequately controlled with the Simple Mode may require fine tuning by switching to PI control. Increasing the value of **PROPORTIONAL GAIN** to any value greater than **SIMPLE MODE** will initiate PI control. Pressure control is achieved by adjusting the values of **PROPORTIONAL GAIN** and **INTEGRAL GAIN**. Larger values for **PROPORTIONAL GAIN** and **INTEGRAL GAIN** give smaller error in the pressure, but also make the system more susceptible to oscillation. The following pages of this Section will provide more information on tuning PI control.

Emergency Over-Pressure Limit Switch

Both digital and analog CP systems have the option of connecting an emergency over-pressure limit switch to the AUX2 terminals in case the main pressure control system fails. The emergency over-pressure set-point should be at least 10 psi higher than the system control pressure to prevent nuisance tripping.

SIMPLE MODE Control in a Digital CP System

Phase Technologies has developed a proprietary controller which involves fewer parameters to tune constant pressure performance. When the **PROPORTIONAL GAIN** parameter is set at the lowest value, the display will read "**SIMPLE MODE**". In **SIMPLE MODE** a set of control equations is used which may not require the user to tune the system to obtain acceptable performance. A well-tuned PI controller will result in smoother pressure control but may not be required. When the controller is in simple mode the only parameters which affect the pressure control loop are the **psi SETPOINT**, **STARTUP RAMP**, **SHUTDOWN RAMP** and **BOOST AMOUNT**, which function in the same way as they do in the PI control mode. Adjusting ramp times may smooth out any oscillation or overshoot in simple mode. If pressure is not adequately controlled, switch to PI control by increasing parameter **PROPORTIONAL GAIN**.

Using PI Control in an Analog CP System

When using an analog pressure transducer for control in constant pressure water systems, it may be desirable to use a proportional-integral (PI) controller in the feedback loop. This type of controller has a proportional gain and integral gain which can be tuned by the user to obtain optimum performance for each application. Increase parameter **PROPORTIONAL GAIN** to switch control from Simple Mode to PI control. It is recommended to start with a parameter value of 5. A proportional gain value too low will

result in slow response time to reach the psi setpoint. A value too high will result in overshoot of the psi setpoint and may create wild oscillation of pressure.

First, attempt to control pressure by adjusting parameter **PROPORTIONAL GAIN**, leaving parameter **INTEGRAL GAIN** at the default value of 50. If adequate control cannot be obtained by adjusting proportional gain, set proportional gain at the value that gives the best control, then adjust integral gain to improve pressure control.

For difficult to control systems, a derivative term can be introduced for PID control, which can help control pressure oscillation and overshoot. Increase the value of parameter DERIVATIVE GAIN to a value greater than zero to enable PID control. This parameter should be used only when necessary as it tends to amplify noise in the transducer signal. The system may become unstable. The parameters **PID FILTER GAIN** and **PID FILTER TIME** help to prevent overshoot. It may be advisable to contact the factory for assistance when using PID control for the first time.

In general, conceptual terms, proportional gain impacts how quickly the system responds to pressure changes and integral gain impacts the accuracy of pressure tracking. Adjusting ramp times can also be considered. Increasing ramp time will damp response to pressure changes, while decreasing ramp time will quicken the response.



CAUTION: Long ramp times can interfere with PI control of constant pressure. It is advisable to start with factory default ramp times.

Pressure Control at Minimum Speed

There is a possibility of conflict between the minimum pump speed setting, controlled by the parameter **MIN FREQUENCY**, and the pressure setting of the transducer. That is, if under no-flow conditions the pump at its minimum speed setting produces a pressure greater than the desired set-point, either the minimum speed will have to be reduced (not an option with submersible pumps) or the pressure set-point will have to be increased. Most pumps should not produce enough pressure head at 30Hz for this to be an issue.

Boost in a Digital Constant Pressure System

In a digital CP system, the drive can only determine the pressure of the system at the set-point. Based on the characteristics of the on/off signals from the switch, which occur at the set-point, it maintains pressure. The parameter **BOOST AMOUNT** in a digital system is a per cent increase in speed, not in pressure, because the digital switch cannot determine a pressure beyond its set-point.

In an analog system the **BOOST AMOUNT** is a specified psi, so the user can accurately control the boost pressure through the parameter setting on the keypad. For example, if boost of 5 psi above control pressure is desired, simply set parameter **BOOST AMOUNT** to 5.

In a digital system **BOOST AMOUNT** is an increase in speed for a given time as a per cent of the speed the pump was running when the switch last opened at the set-point. For example, if pressure is controlled at a speed of 30 Hz, a **BOOST AMOUNT** value of 10 would be 10% of 30 Hz or 3 Hz. In low flow systems where the pressure is controlled at low speed, the **BOOST AMOUNT** value may need to be significantly higher than it would be set in an analog system under the same conditions.

6.2 PerfectPressure™ Setup – Analog Constant Pressure

Upon the first initialization of the unit (or after restoring factory defaults of all parameters using the Two Button Reset Procedure, page 31) the drive will prompt the user to select or decline a quick setup for constant pressure. The display will read **SETUP CONST PRES YES(ENTER)/NO(HOME)**. Press the ENTER key to set up PerfectPressure or the HOME key to decline. Basic parameters for analog constant pressure can be set without navigating through the complete menu options.

Follow this procedure to set up PerfectPressure:

1. **SETUP CONST PRES YES (ENTER) / NO (HOME)** - Press the ENTER key to proceed.
2. **4-20mA psi RANGE** - This parameter sets the range of the 4-20mA pressure sensor. The factory default is 150 since the standard sensor provided by the factory has a maximum range of 150 psi. If necessary, use the arrow keys to change the value, then press ENTER, or simply press ENTER to proceed.
3. **psi SETPOINT** - This value determines the pressure you want to maintain. The factory default is 50 psi. Use the arrow keys to change if desired. Press ENTER to proceed.
4. **SUBMERSIBLE PUMP** - This parameter sets the ramp profile for a submersible pump. **YES = submersible pump, NO = vertical pump**. For submersible pumps, the frequency accelerates from 0-30 Hz in one second, then follows the ramp time from 30 Hz to maximum frequency. If NO is selected the frequency will increase in a linear fashion from zero to max frequency.
5. **ENABLE RESTARTS – YES (ENTER) / NO (HOME)** – enabling restarts controls the ability of the drive to automatically restart after a power failure. The drive will initialize in **AUTO** mode after power is restored if **YES** is selected. If **NO** is selected, the drive will remain **OFF** when power is restored.
6. **OVERCURRENT LIMIT** – Setting for motor overload protection (service factor amp rating for the motor).

 **CAUTION:** Most submersible pump motor manufacturers require the motor to reach 30 Hz within one second to protect the pump from damage. Selecting NO for the parameter above will override the factory default ramp time of 0-30 Hz in one second.

This quick setup of constant pressure should provide good pressure control in most situations. It is advisable to read the entire section on constant pressure control for a complete explanation of constant pressure control methods in LH Series drives. Refer to **Table 18**, for expanded menu options to fine tune the constant pressure system.

6.3 Digital Constant Pressure Systems

The digital CP system uses a digital pressure switch connected to the AUX1 terminals (see **Figure 20** and **Figure 21** for one-line and wiring diagrams). For digital CP systems, the factory default settings will be satisfactory for most CP applications.

Adjusting Parameters in Digital CP Systems

Using the keypad, there are several parameters which can be adjusted to fine tune digital CP systems. These are **MAX FREQUENCY**, **MIN FREQUENCY**, **TOFF**, **T1ON**, **T2ON**, **SLEEP FREQUENCY**, and **BOOST AMOUNT**. The use of these parameters has been discussed in the previous section. **Table 18** also provides more detail.

Digital Constant Pressure Installation Procedures:

1. Install the digital pressure switches in the water line
2. Remove protective rubber boot from each switch, insert factory provided duplex cable through the boot, and connect a twisted pair of wires to the normally closed (NC) and common (C) terminals of the emergency over-pressure switch

 **CAUTION:** The use of shielded cable is recommended. Regular wire may induce capacitance in the line and corrupt the signals from the pressure switches.

3. Attach the cable shield to the Control Terminal Ground post located in the 1LH enclosure adjacent to the Control Terminals
4. Connect the emergency over-pressure limit switch to the AUX2 Control Terminal and COM (common). Use a jumper between AUX2 and COM if no limit switch is present.
5. Navigate through the keypad Main Menu item **CHANGE PARAMETER VALUES > INTERFACE PARAMETERS > SYSTEM CONFIG**. Select **1** to set the system configuration for a digital CP system.
6. To set the emergency over-pressure limit switch, remove the rubber boot from the switch and pry the plastic plug from the top of the switch housing to access the pressure adjustment screw. Use an Allen wrench to adjust the pressure setting of the switch – jumper the AUX1 terminals and run the pump in the AUTO mode, and observe the pressure gauge, turning the Allen screw to adjust the pressure shut-off point. **The emergency over-pressure limit switch should be set at least 10 PSI higher than the desired constant pressure set point.**
7. Remove the jumper from AUX1 and connect the remaining twisted pair of wires in the shielded cable to the normally closed (NC) and common (C) terminals of the control pressure switch. Connect the switch to the AUX1 Control Terminals, and adjust the constant pressure set point using the same procedure as the emergency over-pressure limit switch.
8. Set the keypad to AUTO mode to operate the system.

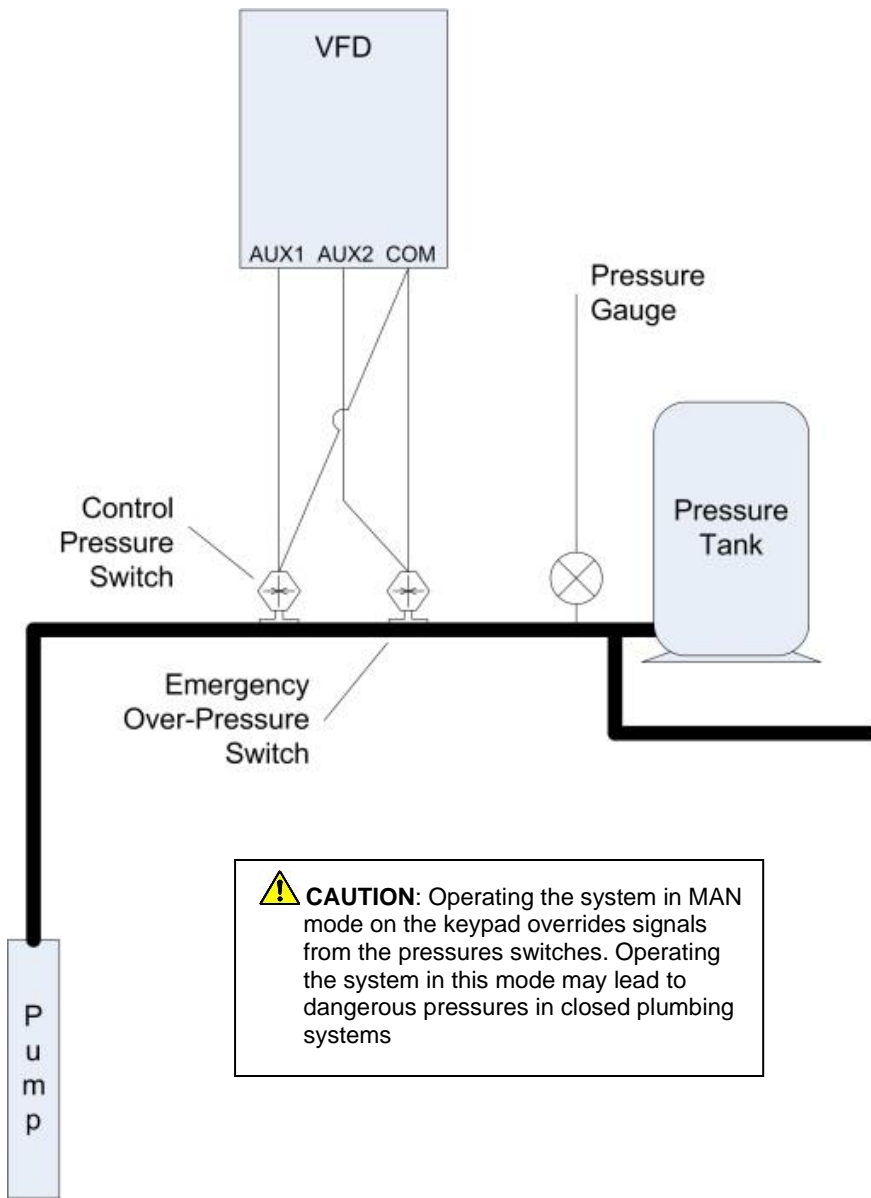

⚠ CAUTION: Operating the system in MAN mode on the keypad overrides signals from the pressures switches. Operating the system in this mode may lead to dangerous pressures in closed plumbing systems

Figure 20 – Digital Constant Pressure Diagram

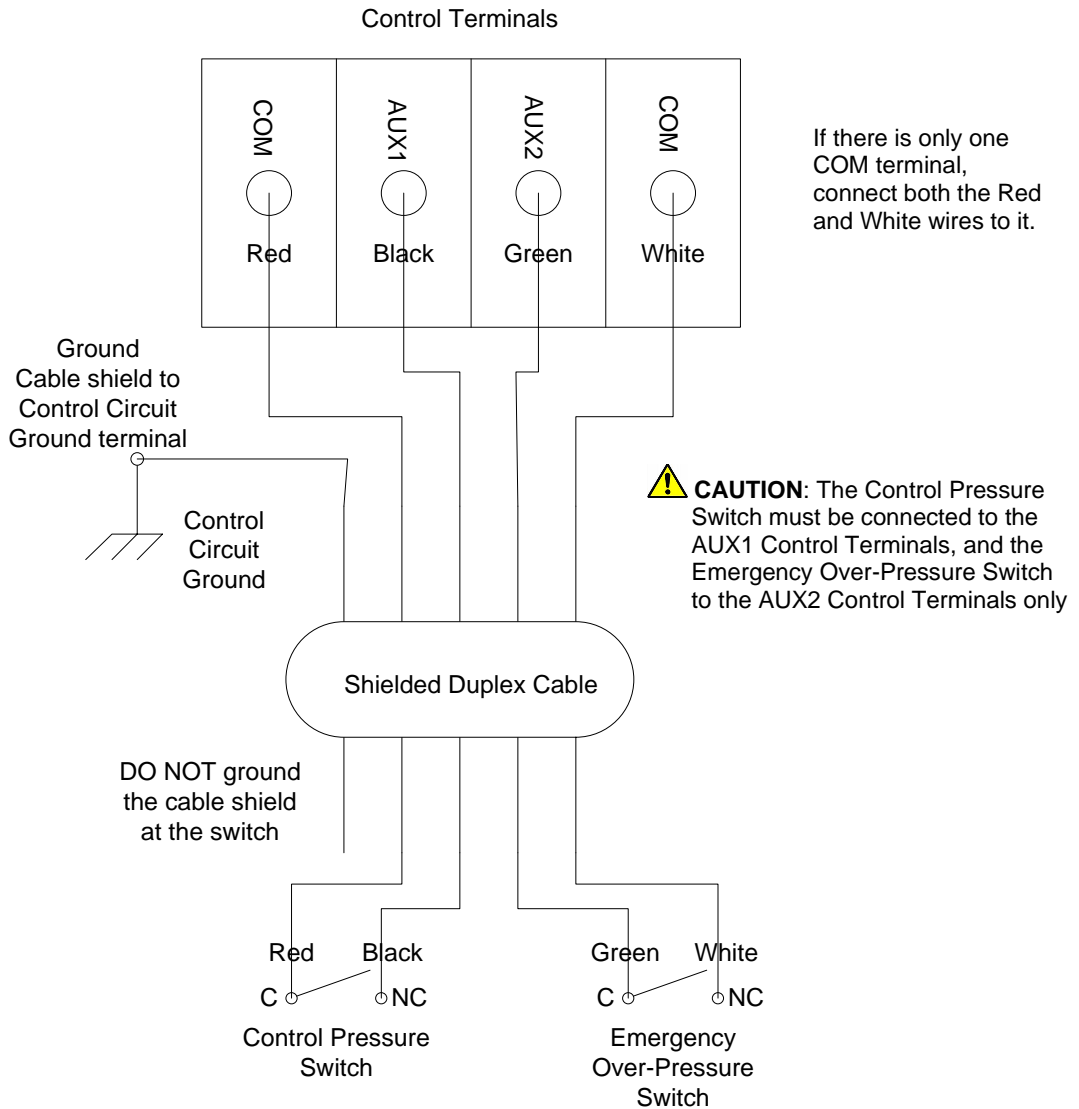

Figure 21 – Digital Constant Pressure System Schematic

6.4 Analog Constant Pressure Systems

The analog CP system uses an analog pressure transducer connected to the analog input on the Control Terminals (see **Figure 22** and **Figure 23** for one-line and wiring diagrams). A normally-closed emergency over-pressure switch connected to the AUX2 terminals is also recommended. These are used in conjunction with the internal firmware of the drive to implement a constant pressure water system.

When using an analog pressure transducer for control in constant pressure water systems, it is very common for the system controller to use a proportional-integral (PI) or proportional-integral-derivative (PID) controller in the feedback loop. This type of controller has a gain adjustment which must be tuned by the user to obtain optimum performance for each application. LH Series drives have this type of controller incorporated in them. However, Phase Technologies has also developed a proprietary controller, Simple Mode, which requires minimal tuning. When the **PROPORTIONAL GAIN** parameter is set at the lowest value, the display will read "**SIMPLE MODE**".

In Simple Mode a set of control equations is used which usually requires minimal tuning of the system to obtain acceptable performance. A well-tuned PI or PID controller will give smoother pressure control and may be necessary to control unstable systems. When the controller is in Simple Mode, the only parameters which affect the pressure control loop are **psi SETPOINT**, **STARTUP RAMP**, **SHUTDOWN RAMP** and **BOOST AMOUNT**.

In PI control mode the analog signal from the pressure transducer is compared to the parameter **psi SETPOINT**, which controls the motor speed to maintain constant pressure in the system. In this control scheme, the error signal between the pressure transducer and the internal signal determined by the **psi SETPOINT** value is multiplied by the **PROPORTIONAL GAIN**. This signal is then used to determine the motor frequency. If the pressure transducer signal and the internal set-point value were the same, then the motor speed would be zero. High **PROPORTIONAL GAIN** and **INTEGRAL GAIN** values give smaller error in the pressure, but also make the system more susceptible to oscillation.

Additional adjustable parameters found in the Constant Pressure menu help to optimize the performance of the system. The use of these parameters was discussed in the previous section. The unit is shipped with default settings which will work in many applications with no adjustment. As with all systems of this type there are tradeoffs between maintaining a tightly controlled set-point, achieving high motor efficiency, and maintaining system stability.

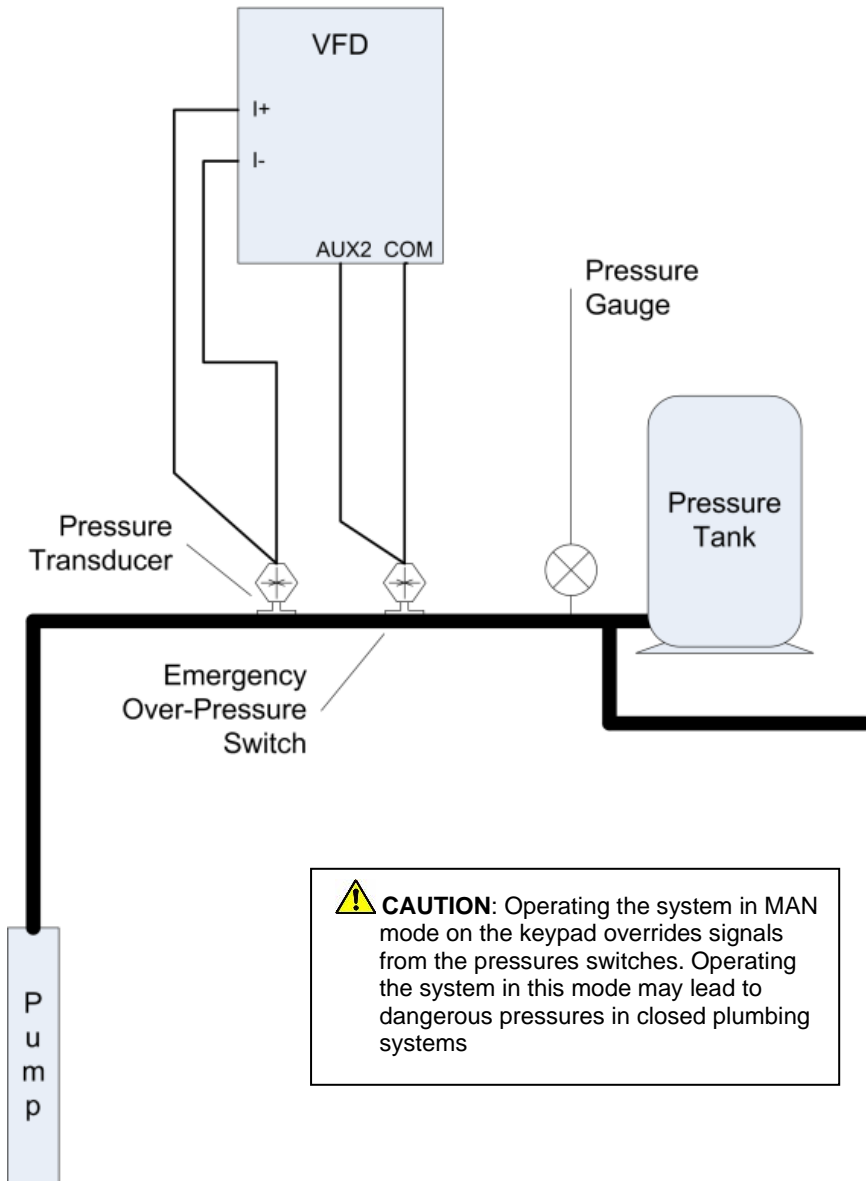



Figure 22 – Analog Constant Pressure One-Line Diagram

Basic Analog Constant Pressure Installation Procedures:

1. Install the analog pressure transducer and emergency over-pressure switch in the water line.
2. Remove protective rubber boot from the over-pressure switch, insert factory provided duplex cable through the boot, and connect a twisted pair of wires to the normally closed (NC) and common (C) terminals of the switch.

 **CAUTION:** The use of shielded cable is recommended. Regular wire may induce capacitance in the line and corrupt the signals from the pressure switches.

3. Attach the cable shield to the Control Terminal Ground post located in the drive enclosure adjacent to the Control Terminals.
4. Connect the emergency over-pressure limit switch to the AUX2 Control Terminal and COM (common). Use a jumper wire to connect AUX2 and COM if no limit switch is present. Also, jumper AUX1 to COM if no external switch is connected to it.
5. Navigate through the keypad Main Menu item **CHANGE PARAMETER VALUES > INTERFACE PARAMETERS > SYSTEM CONFIG**. Select **2** to set the system configuration for an analog CP system (see **Table 18** for details)
6. To set the emergency over-pressure limit switch, remove the rubber boot from the switch and pry the plastic plug from the top of the switch housing to access the pressure adjustment screw. Use an Allen wrench to adjust the pressure setting of the switch – jumper the AUX1 terminals and run the pump in the AUTO mode, and observe the pressure gauge, turning the Allen screw to adjust the pressure shut-off point. **The emergency over-pressure limit switch should be set at least 10 PSI higher than the desired constant pressure set point.**
7. Connect the remaining twisted pair of wires to the + and – terminals of the transducer.
8. Connect the positive terminal of the transducer to the I_1+ Control Terminal, and the negative terminal to the I_1- Control Terminal.
9. If a redundant analog transducer is used, connect it to the I_2+ and I_2- Terminals in likewise fashion. See **Section 5.5, System Configuration**, for instructions on using an additional analog sensor.

 **CAUTION:** It is critical that the positive terminal of the transducer is connected to the + terminal of the 4-20mA Control Terminal, and likewise for the negative terminals.

10. Set the **psi SETPOINT** on the keypad (see **Table 18** for details)
11. Set the keypad to AUTO mode to operate the system.

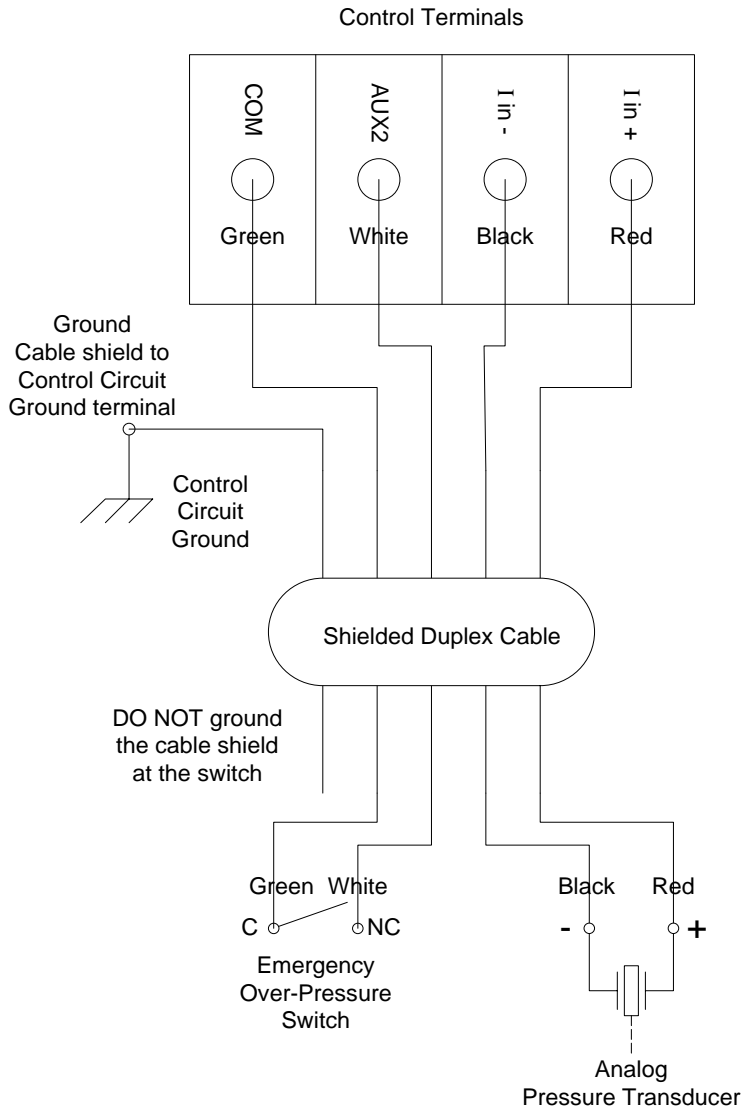

Figure 23 – Analog Constant Pressure System Schematic

6.5 Pre-Charge Mode

When filling a large plumbing system with water, it may be desirable to fill at a slow pump speed so that when the system reaches the full point, water hammer does not cause damage such as sprinkler head blow-off or burst pipes. To achieve this, LH drives are equipped with a pre-charge feature.

Both the digital and analog constant pressure systems can implement a low-flow pre-charge of the system plumbing before the pump is allowed to come to full speed. This feature is disabled if the **PRECHARGE TIME** parameter is set to zero. For both types of CP systems, the frequency of the pump will not exceed the value set by the **PRECHARGE FREQUENCY** parameter during the pre-charge interval.

In a digital CP system, the pre-charge interval is terminated if either the **PRECHARGE TIME** is exceeded or the control pressure is reached.

An analog CP system has the same features with the added option that the pre-charge interval will terminate when the system pressure exceeds the setting of the **PRECHARGE psi** parameter. In this case, the **PRECHARGE psi** must be lower than the **psi SETPOINT**.

In both CP systems the pre-charge interval occurs whenever the drive is switched from OFF to AUTO or MANUAL > RUN.

Pre-charge Mode Setup:

1. Navigate through the keypad menu to **CHANGE PARAMETER VALUES > CONSTANT PRESSURE PARAMETERS > PRECHARGE FREQUENCY** Enter the Pre-charge frequency
2. Navigate through the keypad menu to **CHANGE PARAMETER VALUES > CONSTANT PRESSURE PARAMETERS > PRECHARGE TIME**. Enter the Pre-charge time in seconds
3. For analog CP systems only, navigate through the keypad menu to **CHANGE PARAMETER VALUES > CONSTANT PRESSURE PARAMETERS > PRECHARGE psi**. Enter the pre-charge pressure in psi. This value must be lower than the **psi SETPOINT**
4. Set the keypad to AUTO mode to operate the system.

6.6 Lead/Lag Pump Control

When any analog constant pressure system configuration is selected, the Lead/Lag menu is available. See **Table 19**, Lead/Lag Parameters, for lead/lag control options. Up to four additional pumps can be controlled through programmable relays on the main control printed circuit board. When the parameter **NUMBER LAG PUMPS** is greater than 0, all four relays will convert to control of lead/lag constant pressure.

⚠ CAUTION: Activation of lead/lag control overrides the function of all programmable relays. Any function of these relays set up through the Interface Parameters (**Table 17**) will be disabled.

Lead/lag control in pumping systems is a common practice to maintain pressure with highly variable flow. The system is typically configured with a master pump controlled by a VFD operating in constant pressure mode, and with auxiliary pumps that are controlled by the drive. The auxiliary pumps typically operate across-the-line at 60 Hz. They may be equipped with a soft starter to mitigate inrush currents.

If the master pump cannot maintain system pressure it will call for an auxiliary pump by closing a relay on the Control Terminals. LH Series drives can control up to four auxiliary pumps. There are features to reduce oscillations and ensure smooth staging and de-staging pumps.

Lead/Lag Set-up

System Configuration must be set to one of the constant pressure modes when using lead/lag control. See **Section 5.5**, *System Configuration* for details. Lead/lag control is enabled when the number of lag pumps is set to a value greater than zero in the parameter **NUMBER LAG PUMPS**.

Programming Steps:

1. Use the keypad to navigate to the Main Menu item, **CHANGE PARAMETER VALUES**, then to sub-menu **LEAD LAG PUMP PARAMETERS**. Find the parameter **NUMBER LAG PUMPS** and use the arrow keys to set the number of auxiliary pumps in the system.
2. If necessary, adjust the remaining Lead/Lag parameters after reading the following description of their functions, or after operating conditions dictate.

Lag pumps are turned on and off, or “staged” and “de-staged”, by programmable relays accessed through the Control Terminals. The drive calls for lag pumps in ascending order, beginning with Relay 1. See **Figure 24**, *Programmable Relays for Lead/Lag Control*, to locate the relays. **Figure 25**, *Lead/Lag Schematic*, provides a wiring diagram.

Lead/lag parameters (**Table 19**) are used to smoothly stage the pumps in and out, mitigating pressure oscillation, short cycling, and water hammer. When the master pump cannot maintain pressure, the drive will stage in an auxiliary pump. The drive will de-stage the pump when flow increases pressure beyond the control point.



Programmable relays 1NO/NC, 2NO/NC, 3NO, 4NO.

- CAUTION:** The relays are rated 0-30 VDC or 120VAC, 10 Amp. Direct control of the coil on a magnetic motor starter will likely cause damage to the relay and the main control printed circuit board. Use of a secondary control relay, such as an ice cube relay, may be necessary to control the lag pump motor starter.

Figure 24 – Programmable Relays for Lead/Lag Control

Two conditions must be met to stage a pump:

1. The system psi has decreased to a pressure equal to **psi SETPOINT** minus **STAGE PSI LAG**. For example, if the **psi SETPOINT** is 50 psi and you want to stage a pump in at 45 psi, **STAGE PSI LAG** should be set to a 5.
2. The time set by **STAGE PUMP DELAY** has expired. This delay allows momentary drop in system pressure without calling for a pump to stage in.

Pumps are staged in the following sequence:

1. The relay will open to de-stage the pump.
2. The speed of the master pump will increase to a value equal to **MIN FREQUENCY** plus **DESTAGE FREQ BOOST**. For example, if **MIN FREQUENCY** is 30 Hz and **DESTAGE FREQ BOOST** is 5 Hz, the pump speed will be reduced to 35 Hz.
3. The master pump will operate at increased speed for a period set by **DESTAGE TIME**.
4. When **DESTAGE TIME** has expired the system will resume normal constant pressure control.

Pumps are de-staged when the drive has slowed the master pump to maintain control pressure and the auxiliary pump(s) causes a rise in pressure.

Three conditions must be met to de-stage a pump:

1. The system psi has increased to the value set by **DESTAGE PSI LAG** above **psi SETPOINT**. For example, if **psi SETPOINT** is 50 and **DESTAGE PSI LAG** is 5 the pump will de-stage at 55 psi.
2. The time set by **DESTAGE PUMP DELAY** has expired. This delay prevents de-staging the auxiliary pump due to momentary pressure overshoot.
3. The drive frequency to the master pump is between **MIN FREQUENCY** and the value of **DESTAGE MIN FREQ** plus **MIN FREQUENCY**. For example, if **MIN FREQUENCY** is 30 Hz and **DESTAGE MIN FREQ** is 5 Hz, the pump will de-stage at 35 Hz.

Pumps are de-staged in the following sequence:

1. The system pressure will increase by the value set by **DESTAGE FRQ BOOST**. This boost in pressure allows the PI constant pressure loop to react faster to the drop in pressure when the pump turns off.
2. The system will de-stage the pump
3. The system will continue to boost the pressure set by **DESTAGE FRQ BOOST** for a period set by **DESTAGE TIME**.
4. The system will resume normal constant pressure control.

Pre-charge Pumps Feature

In some systems the primary pump may not have the capacity to pre-charge the system on its own. The **PRECHARGE PUMPS** parameter will set the number of auxiliary pumps that will be called on to pump during the pre-charge interval. When the pre-charge interval is terminated, normal lead/lag control of the pumps will resume.

 **CAUTION:** This number should never be greater than the total number of lag pumps as it will activate the associated programmable relay which may be reserved for other functions.

6.7 Duplex / Multiplex Control

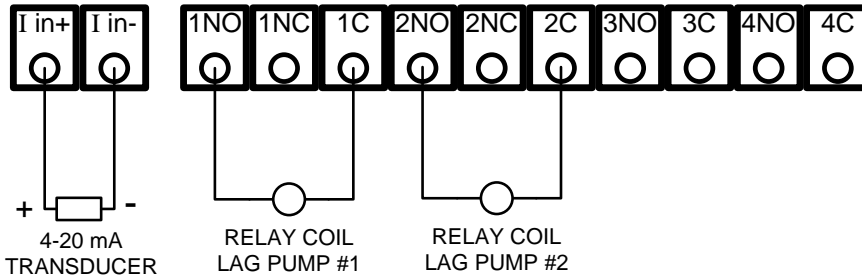

Use the relays in order, beginning with Relay 1.

CAUTION: The relays are rated 0-30 VDC or 120VAC, 0.5 amp. Direct control of the coil on a magnetic motor starter will likely cause damage to the relay and the main control printed circuit board. Use of a secondary control relay, such as an ice cube relay, may be necessary to control the lag pump motor starter.

Figure 25 – Connecting Duplex/Multiplex Systems

When any analog constant pressure system configuration is selected, the CONSTANT PRESSURE and LEAD/LAG menus are available. Up to four additional VFDs can be controlled through the relays. When the parameter **NUMBER LAG PUMPS** is greater than 0, relays will convert to control of lead/lag or duplex/multiplex constant pressure in sequence. *Example: If 2 lag pumps are entered, Relay 1 & Relay 2 will now be used for Lead/Lag pump control.* In addition, the parameter **DUPLEX CYCLE TIME** must be greater than 0 for Multiplex control to be active.

When operating in Multiplex Control, the main VFD will assume the role of Master, and all auxiliary VFDs controlled through the relays are known as Slaves. The Master and Slave VFDs will operate in constant pressure mode.

If the Master VFD senses that system pressure cannot be maintained, it will call for a Slave VFD by closing a relay on the Control Terminal. LH and DX Series drives can control up to four auxiliary VFDs.

In Multiplex control, the Master VFD might not always be the drive that is operating. The point of a multiplex system is to rotate the use of each available VFD. This is done so that a single drive or pump does not degrade at a faster rate than other drives or pumps in that system. The Master VFD will decide when to stage or de-stage a VFD. The first pump to be staged in, and the last pump to be de-staged, is called the Default VFD.

Multiplex Setup

System configuration must be set to one of the constant pressure modes when using multiplex control. See **Section 5.5, System Configuration**, for details. Multiplex control is enabled when **NUMBER LAG PUMPS** is greater than 0, and **DUPLEX CYCLE TIME** is greater than 0.

Programming Steps:

1. Use the keypad to navigate to the Main Menu item, CHANGE PARAMETER VALUES, then to sub-menu LEAD LAG PUMP PARAMETERS. Find the parameter **NUMBER LAG PUMPS** and use the arrow keys to set the number of auxiliary drives in the system.
2. Navigate to CONSTANT PRESSURE PARAMETERS and find the parameter **DUPLEX CYCLE TIME**, use the arrow keys to set how often the Default drive position will change.
3. If necessary, adjust the remaining Lead/Lag parameters after reading the following description of their functions, or after operating conditions dictate.

In Multiplex control, the Master VFD will utilize the Lead/Lag Parameters and logic similar to lead/lag control in order to decide when to turn on/off a VFD. More detail on the logic behind these decisions will be given in a later section.

It is recommended to run all auxiliary pumps on VFDs, otherwise pressure instability may occur. The Primary Auxiliary Pump could turn on/off resulting in the system pressure oscillating from **(psi SETPOINT – STAGE PSI LAG)** to **(psi SETPOINT + DESTAGE PSI LAG)**.

The Master VFD stages in VFDs in a different order depending on which VFD is the Primary. When the Master VFD is not the Primary, it will ALWAYS be the second drive to be staged in. The tables below will illustrate the order of the VFDs to be staged or de-staged for different values of **NUMBER LAG PUMPS**.

The Primary drive position will rotate based on the parameter **DUPLEX CYCLE TIME**.

Master + 1 Slave VFD		
Rotation	Primary Drive	VFD Order
1 st Rotation	Master	M <=> 1
2 nd Rotation	Slave VFD 1	1 <=> M

Master + 2 Slave VFD		
Rotation	Primary Drive	VFD Order
1 st Rotation	Master	M <=> 1 <=> 2
2 nd Rotation	Slave VFD 1	1 <=> M <=>> 2
3 rd Rotation	Slave VFD 2	2 <=> M <=> 1

Master + 3 Slave VFD		
Rotation	Primary Drive	VFD Order
1 st Rotation	Master	M <=> 1 <=> 2 <=> 3
2 nd Rotation	Slave VFD 1	1 <=> M <=> 2 <=> 3
3 rd Rotation	Slave VFD 2	2 <=> M <=> 3 <=> 1
4 th Rotation	Slave VFD 3	3 <=> M <=> 1 <=> 2

Master + 4 Slave VFD		
Rotation	Primary Drive	VFD Order
1 st Rotation	Master	M <=> 1 <=> 2 <=> 3 <=> 4
2 nd Rotation	Slave VFD 1	1 <=> M <=> 2 <=> 3 <=> 4
3 rd Rotation	Slave VFD 2	2 <=> M <=> 3 <=> 4 <=> 1
4 th Rotation	Slave VFD 3	3 <=> M <=> 4 <=> 1 <=> 2
5 th Rotation	Slave VFD 4	4 <=> M <=> 1 <=> 2 <=> 3

Two conditions must be met to stage in a VFD:

1. The system has decreased to a pressure equal to **psi SETPOINT** minus **STAGE PSI LAG**.
NOTE: Primary Slave VFDs and Primary Master Drives will ignore the **STAGE PUMP DELAY** parameter, and immediately stage in if the system pressure drops below the threshold.
2. The time set by **STAGE PUMP DELAY** has expired. This delay allows a momentary drop in system pressure without calling for a drive to stage in.

Steps To Stage A Drive:

1. The selected drive will be staged in. The selected drive is based on the order given in the tables above. This will either close the Slave VFD's corresponding relay or move the Master VFD out from sleep mode.
2. The speed of the master pump will decrease to a value equal to **MAX FREQUENCY** minus the corresponding **STAGE FREQ REDUCTION**.
3. The Master VFD will operate at a reduced speed for a period set by **STAGE TIME**.
4. When **STAGE TIME** has expired the system will resume normal constant pressure control.

Note: The Master VFD does NOT have corresponding **STAGE FREQ REDUCTION** or **STAGE TIME** parameters.

De-Staging:

Drives are de-staged when the drive has slowed the master pump to maintain control pressure and the Slave VFD(s) causes a rise in pressure.

Three conditions must be met to de-stage a VFD:

1. The system psi has increased to the value set by **psi SETPOINT** plus **DESTAGE PSI LAG**.
2. The time set by **DESTAGE PUMP DELAY** has expired. This delay prevents de-staging VFDs due to momentary pressure overshoot.
3. The Master drive frequency is between **MIN FREQUENCY** and the value of **MIN FREQUENCY** plus **DESTAGE MIN FREQ**.

Steps To De-Stage A Drive:

1. The selected drive will be de-staged. The selected drive is based on the order given in the tables above. This will either open the Slave VFD's corresponding relay or set the Master VFD to sleep mode.
2. The frequency of the master pump will increase by **DESTAGE FREQ BOOST**.
3. The Master VFD will operate at an increased speed for a period set by **DESTAGE TIME**.
4. When **DESTAGE TIME** has expired the system will resume normal constant pressure control.

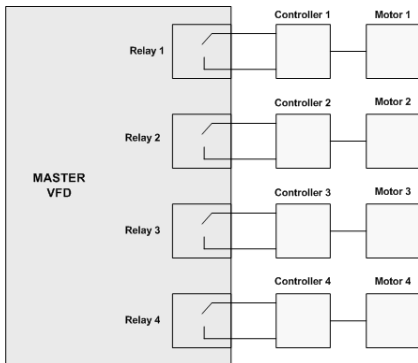

Note:

Only one controller is necessary for Lead/Lag or Multiplex but up to four are available.

Figure 26 – Lead/Lag or Multiplex Block

Note: Setting **PROGRAM RELAY 1** to setting 6, Jockey Pump, will cause Relay 1 to not participate in lead/lag or multiplex control. The order pumps are staged or destaged will remain the same, except the Master will skip Relay 1. Relay 1 will also never become the Primary when it is set to Jockey Pump.

6.8 Troubleshooting Constant Pressure Systems

A variety of conditions in a plumbing system can lead to less than optimum performance of constant pressure control while using the factory default settings. The default settings are designed to operate a range of plumbing systems, but there can be many variables in a plumbing system that requires adjustment of the constant pressure parameters.

For the drive to enter sleep mode while operating in CP mode, three conditions must be met:

1. The pressure in the system must be at the pressure control point set by the parameter **psi SETPOINT** (for analog systems) or at the pressure determined by the setting on the digital pressure switch
2. The frequency is below **SLEEP FREQ** (as defined as **MIN FREQUENCY** + input value) or measured pressure is above **WAKE UP psi** (as defined as **psi SETPOINT** + the input value).
3. The time expired since the pump started after the last OFF cycle must be greater than parameter **T10N** or **T20N**

When these conditions have been met, the drive will go to sleep. The duration of which the drive is asleep depends on the rate at which the system bleeds down and the width of the dead band. When setting and testing a constant pressure system, try to operate as close as possible to the normal operating conditions. Low flow in a high-capacity system (and vice versa) usually requires some adjusting of the parameters.

7 TROUBLESHOOTING

This section provides information on fault codes and troubleshooting tips for potential system problems.

 **WARNING!** In some instances, the unit will shut down, then automatically restart when conditions allow. Always disconnect input power from the unit and wait for internal electrical charges to dissipate before performing service on the unit or its connected loads.

 **WARNING:** Risk of electric shock. De-energize the unit by disconnecting all incoming sources of power, then wait 5 minutes for internal charges to dissipate before servicing the equipment.

 **HIGH VOLTAGE:** This equipment is connected to line voltages that can create a potentially hazardous situation. Electric shock could result in serious injury or death. This device should be installed and serviced only by trained, licensed, and qualified personnel. Follow instructions carefully and observe all warnings.

Always check the display for fault codes if the drive or its load is not operating. Disconnecting the input power could potentially clear any fault code indication, possibly losing valuable information for troubleshooting.

7.1 Fault Codes

Fault codes are indicated on the graphic display. See **Table 22**, on page 75, for a list of fault codes.

The drive can be programmed to automatically restart after certain faults and a time delay can be programmed before the restart is allowed. To interrupt a time delay countdown and allow auto restart, press both arrow keys on the keypad and hold for one second. The load will start immediately. The Restart Log is a resettable fault log that can be used to monitor faults that allow auto restart. Use the Clear Memory function to reset the Restart Log and set all fault counters to zero. See Section 4.2, Keypad Main Menu Items, for more information on Restart Log and Clear Memory function.

 **WARNING:** Certain faults do not allow an auto restart. These faults generally indicate the possibility of damage to the drive and/or the load or indicate the possibility of a dangerous condition. When this type fault occurs, the display will read **NO AUTO RESTART**. Refer to Table 8-1, *Fault Codes*, to determine if the fault allows an auto restart. The number 1 in the notes column indicates that auto restart is not allowed. When this type fault occurs, contact the factory for assistance before restarting or troubleshoot the system thoroughly. **These faults can be cleared only by cycling input power OFF/ON or by pressing both arrow keys for 3 seconds.**

 **WARNING:** Unit may restart automatically without warning after a fault when operating conditions permit. Make certain input power is disconnected before servicing the unit or its connected loads.

7.2 Clearing a Fault

If the unit is programmed to automatically restart after a particular fault, the display indicates that the unit will restart and will count down the seconds remaining to restart on the display. The countdown can be interrupted by pressing and holding both arrow keys. The load will immediately restart.

For faults that allow an automatic restart, the default number of restarts after a fault is zero. If the end user desires the unit to automatically restart after a fault, the number of restarts allowed and the time between fault and restart must be programmed in the **CHANGE PARAMETER VALUES > AUTO RESTART PARAMETERS** for that fault.

If the drive has exceeded the programmed number of auto restarts, or if auto restarts have not been enabled, the display will indicate the fault on the top line and the second line will read **RESTART? ENTER**. Press ENTER to clear the fault and restart the load. The fault counters in the Restart Log will all be reset to zero. See **Section 3.6, Restart Log**, for more information.

The **ENABLE RESTART** parameter allows the drive to restart automatically after a fault. This parameter also enables the drive to initialize in AUTO mode when the input power has been cycled OFF/ON and the drive is energized. The factory default setting does not allow auto restarts. Navigate to this parameter via **CHANGE PARAMETER VALUES > AUTO RESTART PARAMETERS > ENABLE RESTART**. See **Table 16** for values in setting the parameter.

Certain faults do not allow an auto restart. These faults generally indicate the possibility of damage to the drive and/or the load or indicate the possibility of a dangerous condition. When this type fault occurs, the display will read **NO AUTO RESTART**. When this type fault occurs, contact the factory for assistance before restarting or troubleshoot the system thoroughly. **These faults can be cleared only by cycling input power OFF/ON or by pressing both arrow keys for 3 seconds.**

There are several conditions where the drive will indicate a fault, but the fault will not be recorded in the fault log. These faults occur only when the drive is energized from utility mains and is initializing. If any condition including ground fault, pre-charge fail, high input voltage or low input voltage is detected, the display will indicate the fault and wait for the condition to resolve before entering normal operating mode. If these conditions occur after the drive has initialized, a fault will be logged and can be cleared in the normal manner.

 **WARNING:** The drive may start automatically without warning when operating conditions permit. Make certain input power is disconnected before servicing the unit or its connected loads.

Table 22 – Fault Codes

TEXT MESSAGE	DESCRIPTION / COMMENTS	NOTES
15 V Power Supply Overload	Customer terminal power supply has been overloaded. Cycle power or wait for fault delay to reset. (Restart Delay 2)	1
AUX1 Latch Fault	Switch connected to AUX1 input has opened. Drive will remain off until fault is cleared. No auto restart allowed. See parameter AUX1 SELECT in Table 17 for details.	P, 1
AUX2 Latch Fault	Switch connected to AUX2 input has opened. Drive will remain off until fault is cleared. No auto restart allowed. See parameter AUX2 SELECT in Table 17 for details.	P, 1
AUX3 Latch Fault	Switch connected to AUX3 input has opened. Drive will remain off until fault is cleared. No auto restart allowed. See parameter AUX3 SELECT in Table 17 for details.	P, 1
AUX4 Latch Fault	Switch connected to AUX4 input has opened. Drive will remain off until fault is cleared. No auto restart allowed. See parameter AUX4 SELECT in Table 17 for details.	P, 1
AuxPower Output Fault	The auxiliary output inverter module has experienced a sudden high current. Check for short circuit on the load.	1
AuxPower Overload	AuxPower current has exceeded the value set by Auxpower Current Limit	2
Broken Pipe Fault	Indicates the possibility of a broken pipe. Fault is triggered by a large drop in pressure. Check the settings of the parameter Broken Pipe psi to eliminate the possibility of nuisance fault.	1
Bus Overvoltage	Sudden and severe regenerative power under high line voltage conditions may result in bus overvoltage. Check line voltage or consider increasing ramp up and ramp down times.	2
Bus Voltage Unbalance	The DC bus voltages are more than 10% unbalanced. Can be caused by bus cap failure.	1
CM Connection Fail	Cables to current measurement boards have been disconnected. Check RJ45 cables.	
Current Unbalance	Motor current unbalance has exceeded the limit set by parameter Current Unbalance . Check motor load for normal operation or increase current unbalance limit.	P, 2
Defect Hall Snr	This is likely a connection issue with the hall sensor board. Power the system down, check the connections to the hall sensor PCB (blue cubes with wires/bus bars running through them). Power up the system. If this does not clear the fault, please contact customer service. A Hall PCB may need to be replaced.	
Dry Well Current	Motor current has fallen below the value set by parameter Dry Well Current . Commonly used to detect dry well condition.	P, 2
Dry Well KW	Real power in kW consumed by the motor load has fallen below the limit set by parameter Dry Well KW . Commonly used to detect dry well condition.	P, 2
Ground Fault	A fault between an output line and earth has been detected. Immediately disconnect input power and check output lines with a megger to verify a fault. Nuisance trip is a possibility. Sensitivity of fault detection can be adjusted by the Operating Parameter Ground Fault Detect Sensitivity . See Table 15 for details.	1

TEXT MESSAGE	DESCRIPTION / COMMENTS	NOTES
High Input Voltage	Input voltage has exceeded a level for safe operation. Reduce input voltage. General purpose buck/boost transformers are compatible with LH Series drives.	2
Input 1Ph Fault	Single-phase input fault. Indicates a loss of phase on the input 3-phase lines, or severe voltage unbalance.	2
Input Fault	Sudden high input current or internal fault. Contact factory	1
Input Overload	Current on the input module has exceeded safe levels. Check for reduced input voltage as this may increase input current. May also be caused by high current in the motor circuit.	1
IP Hall Sense Hi	A current on the input module large enough to exceed the maximum current rating of the hall effect sensor. May indicate a fault in the motor circuit or internal fault.	2
Line Cap Fail	Indicates failure of a filter capacitor on the input L/C filter. Contact factory for assistance.	
Low Input Voltage	Input voltage has fallen below a level for safe operation of the drive.	2
Motor Overload	Output current has exceeded the value set by parameter Overcurrent Limit . Check status of motor load. If output current limit is increased, make sure it is within the limit of the motor nameplate. Automatic restarts are set by Restart Delay 1 and Restarts Motor Overload in the AUTO RESTART PARAMETERS menu.	P, 2
OP Hall Sense Hi	A current on the output module large enough to exceed the maximum current rating of the hall effect sensor. May indicate a fault in the motor circuit or internal fault.	2
Output Fault	Indicates short in motor circuit. Check for short circuit on output lines and load. Contact factory	1
Output Overload	Indicates a large and sudden overcurrent event on the output module. Check the motor circuit for faults. The overcurrent event may be of a very short duration that cannot be captured by amp meters.	
Over Temperature	Internal temperature of the drive exceeded safe limits. Check fans and ventilation openings for obstruction. Reduce ambient temperature.	2
Pre-charge Fail	Indicates that the bus voltage was not charged to an adequate level by the pre-charging circuit. Contact factory for assistance.	1
Sensor Connection Fail	4-20mA analog signal is not present on Control Terminals I_1 and I_2. This could indicate failure of the 4-20mA sensor or that the cables from the sensors have been disconnected.	2
Sensor Fault	Indicates a fault on the I_1 or I_2 control circuit	2
Temp Sense Fault	Solid state temperature sensor on the heat sink has failed or its cable is disconnected. Contact factory.	1

P = Fault may be related to an adjustable parameter. Always check the value of the parameter to eliminate nuisance tripping.

1 = Drive has shut down due to a potentially dangerous condition. Drive will remain OFF until fault is cleared. Use caution if the drive is restarted. Thoroughly troubleshoot the system and/or contact the customer service for assistance.

2 =  **WARNING:** Auto restart allowed for this fault. Motor may restart automatically without warning after a fault when operating conditions permit. Make certain input power is disconnected before servicing the unit or its connected loads.

Fault Log

The Fault Log records the number of times a particular fault has occurred. To access the Fault Log, press the MENU key until the Main Menu item, **FALUT LOG**, appears.

Press ENTER key to access the list of faults. The Fault Log will continue to log the number of faults that have occurred until it is reset through the Main Menu item **RESTART LOG or CLEAR MEMORY**. The Fault Log is not to be confused with the restart counter. The restart counter is associated with the automatic restart function and is reset whenever the input power is cycled OFF/ON.

Table 23 – Troubleshooting

PROBLEM	POTENTIAL CAUSE	SOLUTION
Unit does not power up	Circuit breaker tripping	If incoming circuit breaker continually trips when VFD starts, the breaker and cable sizes should be sized by a certified electrician. Increase breaker size is recommended by electrician.
	Blown fuses	Replace fuses on power board and chassis. See Section 8 for fuse locations. If fuses keep blowing, troubleshoot the following systems: <ul style="list-style-type: none"> • Fans • Power Board • Control Board • IGBTs
Motor not running	Is a fault code indicated?	Based on the fault code, resolve any factors that are likely causing the fault. Clear the fault by pressing both arrow keys on the keypad or by cycling input power OFF/ON.
	Are the remote switches AUX1 and AUX2 closed?	Check the status of the switches or jumpers connected to AUX1 and AUX2 on the Control Terminals. The LCD display indicates the status of AUX terminals in the default display mode. All AUX terminals must be closed for the motor to run in AUTO mode.
	Are the signals to the Control Terminals corrupted?	Shielded cable is required for AUX terminal switch leads longer than 20 ft. Regular wire will induce capacitance in the line and corrupt control signals. Shielded cable is recommended for all Control signal cables.
	Is the keypad in MAN or OFF mode?	The keypad will override signals on the Control Terminals when OFF or MAN is selected. Keypad must be in AUTO mode for external control signals to control the motor.
	Is the maximum frequency set at 0 Hz?	Check the maximum frequency by using the keypad to navigate MAIN MENU>CHANGE PARAMETER VALUES>OPERATING PARAMETERS>MAX FREQUENCY .
	Are the input terminals L1 and L2 energized?	Green LED D9 on the Master Control printed wiring board should be on to indicate board is powered. Green flashing D16 indicates the program is running. If no LEDs are lit on the PWB, check the main input fuses or breaker, then check secondary fuses. See Figure 30 - Figure 32 for fuse locations.
Motor is turning the wrong direction	Phase sequence on output terminals U/T1, V/T2, W/T3 is out of order	Swap any two of the three motor leads on the output terminals OR use parameter REVERSE ROTATION via keypad.
Real Time Clock (RTC) clearing or not providing fault time stamps	Dead battery	Replace CR2032 battery, located on Control Board beneath graphic display.

8 ROUTINE INSPECTION AND MAINTENANCE

The unit should be inspected and cleaned at least annually or more frequently if it is in an excessively warm or dusty environment.

Overall: Perform a visual inspection checking for things such as discolored wires or terminals, evidence of arcing, loose mounting screws, physical damage to the enclosure, etc.

Power terminals: Inspect for loose connections and tighten to specifications in **Table 2** and **Table 3**.

Capacitors: Check for leakage or deformation.

Fans and heatsinks: Excessive dust buildup on the heatsink and cooling fan impellers may lead to overheating. Lightly brush and vacuum clean. Contact Customer Service for assistance in replacing the cooling fan in the event it should fail. Use only fans approved by Phase Technologies. Unapproved fans may not be able to move enough air to properly cool the unit, leading to component damage.

Line Filter Capacitors

Line filter capacitors are part of the inductor/capacitor (L/C) filters that filter harmonics from either the input lines or output lines of the drive. While it is extremely rare for the inductor to fail, capacitors are inherently more prone to degradation and failure and should be routinely monitored and/or replaced. Failure of the L/C filter can lead to increased harmonic levels which may damage equipment connected to the drive.



CAUTION: Line Filter Capacitors

Line filter capacitors should be inspected annually at a minimum. **Replacement of the capacitors every three years is recommended as preventive maintenance.** If they are degraded the electrical noise can damage equipment connected to the drive.

Line filter capacitors should be visually inspected and electrically tested on a routine basis. The capacitors are easily accessible. See **Figure 27** and **Figure 28** below to locate the line filter capacitors.

Visually inspect the line filter capacitors and the wires connected to them for any discoloration and for bulges in the canister.

Capacitors are connected in two different configurations, either line-to-line or line-to-ground. The capacitors have electrical ratings in both voltage and capacitance measured as microfarads (uF).

Drives equipped with optional AUX POWER™ have five line-to-ground capacitors, while models without the option have two. All models have line-to-line capacitors.

Using a multi-meter set to measure capacitance, check the capacitance of each capacitor by measuring between the two terminals on the capacitor. **Remove the wire from at least one terminal of the capacitor in order to obtain an accurate measurement.** Compare to the capacitor value in **Table 24** and **Table 25**. If any capacitor value is less than specified by more than 25% contact Phase Technologies customer support at 605-343-7934 to order replacement capacitors. If you do not have a meter or other means to test the capacitors it is recommended to replace the capacitors every three years as a preventive measure. Do not operate the drive with degraded capacitors.

Table 24 – Line-to-Line Capacitors

Drive Model	No. Capacitors	Capacitor Value	Phase Technologies PN
1LHE005	1	35 uF 480V	AC0027
1LHE007	1	35 uF 480V	AC0027
1LHE010	1	35 uF 480V	AC0027
1LHE015	1	35 uF 480V	AC0027
1LHE020	1	35 uF 480V	AC0027
1LHE205	1	35 uF 480V	AC0027
1LHE207	1	35 uF 480V	AC0027
1LHE210	1	35 uF 480V	AC0027
1LHE215	1	35 uF 480V	AC0027
1LH220, 1LHS220, 1LHE220	1	35 uF 480V	AC0027
1LHE225	1	35 uF 480V	AC0027
1LH230, 1LHS230	1	35 uF 480V	AC0027
1LH240, 1LHS240	2	35 uF 480V	AC0027
1LH250	2	35 uF 480V	AC0027
1LHE405	1	35 uF 480V	AC0027
1LHE407	1	35 uF 480V	AC0027
1LHE410	1	35 uF 480V	AC0027
1LHE415	1	35 uF 480V	AC0027
1LH420, 1LHS420, 1LHE420	1	35 uF 480V	AC0027
1LHE425	1	35 uF 480V	AC0027
1LH430, 1LHS430, 1LHE430	1	35 uF 480V	AC0027
1LH440, 1LHS440	1	35 uF 480V	AC0027
1LH450, 1LHS450	1	35 uF 480V	AC0027
1LH460, 1LHS460	1	35 uF 480V	AC0027

Drive Model	No. Capacitors	Capacitor Value	Phase Technologies PN
1LH460-C	2	35 uF 480V	AC0027
1LH475, 1LHS475	2	35 uF 480V	AC0027
1LH4100, 1LHS4100	2	35 uF 480V	AC0027
1LH4125	NA	NA	NA
3LHE005	1	10.5 uF 500V	C00058
3LHE007	1	21 uF 500V	C00059
3LHE010	1	21 uF 500V	C00059
3LHE015	1	21 uF 500V	C00059
3LHE020	1	21 uF 500V	C00059
3LHE025	1	53 uF 500V	C00061
3LHE030	1	53 uF 500V	C00061
3LHE205	1	10.5 uF 500V	C00058
3LHE207	1	10.5 uF 500V	C00058
3LHE210	1	21 uF 500V	C00059
3LHE215	1	21 uF 500V	C00059
3LH220, 3LHS220, 3LHE220	1	21 uF 500V	C00059
3LHE225	1	21 uF 500V	C00059
3LH230, 3LHS230	1	53 uF 500V	C00061
3LH240, 3LHS240	1	53 uF 500V	C00061
3LH250, 3LHS250	1	64 uF 500V	C00062
3LH260, 3LHS260	2	53 uF 500V	C00061
3LHE405	1	10.5 uF 500V	C00058
3LHE407	1	10.5 uF 500V	C00058
3LHE410	1	10.5 uF 500V	C00058
3LHE415	1	10.5 uF 500V	C00058
3LH420, 3LHS420, 3LHE420	1	21 uF 500V	C00059
3LHE425	1	21 uF 500V	C00059
3LH430, 3LHS430, 3LHE430	1	21 uF 500V	C00059

Drive Model	No. Capacitors	Capacitor Value	Phase Technologies PN
3LH440, 3LHS440, 3LHE440	1	21 uF 500V	C00059
3LH450, 3LHS450, 3LHE450	1	32 uF 500V	C00060
3LH460, 3LHS460	1	53 uF 500V	C00061
3LH475, 3LHS475	1	53 uF 500V	C00061
3LH4100, 3LHS4100	1	64 uF 500V	C00062
3LH4125, 3LHS4125	2	53 uF 500V	C00061
3LH4150, 3LHS150	2	53 uF 500V	C00061
3LH4200, 3LHS4200	2	64 uF 500V	C00062
3LH4250	2	64 uF 500V	C00062
3LH4300	2	64 uF 500V	C00062
3LH4350	2	64 uF 500V	C00062
3LH4400	2	64 uF 500V	C00062
3LH4450	2	64 uF 500V	C00062
All DX, DXS, 1DXS, & DXE Models	NA	NA	NA
All SDE Models	NA	NA	NA

Table 25 - Line-to-Ground Capacitors

Drive Model	No. Capacitors	Capacitor Value	Phase Technologies PN
1LH220, 1LHS220	2	0.47 uF, 1200V	AC0033
1LH220C	2	0.47 uF, 1200V	AC0033
1LH230, 1LHS230	2	0.47 uF, 1200V	AC0033
1LH230C	2	0.47 uF, 1200V	AC0032
1LH240, 1LHS240	2	0.47 uF, 1200V	AC0032
1LH250	2	0.47 uF, 1200V	AC0032
1LH420, 1LHS420	2	0.47 uF, 1200V	AC0033
1LH420C	2	0.47 uF, 1200V	AC0033
1LH430, 1LHS430	2	0.47 uF, 1200V	AC0033
1LH430C	2	0.47 uF, 1200V	AC0033
1LH440, 1LHS440	2	0.47 uF, 1200V	AC0033
1LH440C	2	0.47 uF, 1200V	AC0033
1LH450, 1LHS450	2	0.47 uF, 1200V	AC0033
1LH450C	2	0.47 uF, 1200V	AC0033
1LH460, 1LHS460	2	0.47 uF, 1200V	AC0032
1LH460C	2	0.47 uF, 1200V	AC0032
1LH475, 1LHS475	2	0.47 uF, 1200V	AC0032
1LH475C	2	0.47 uF, 1200V	AC0032
1LH4100, 1LHS4100	2	0.47 uF, 1200V	AC0032
1LH4100C	2	0.47 uF, 1200V	AC0032
1LH4125	NA	NA	NA
All 1LHE Series	2	0.47 uF, 1200V	AC0133
All 3LH & 3LHS Models	3	0.47 uF, 1200V	AC00134
All 3LHE Models	3	0.47 uF, 1200V	AC00133
All DX, DXS, 1DXS, & DXE Models	NA	NA	NA
All SDE Models	NA	NA	NA

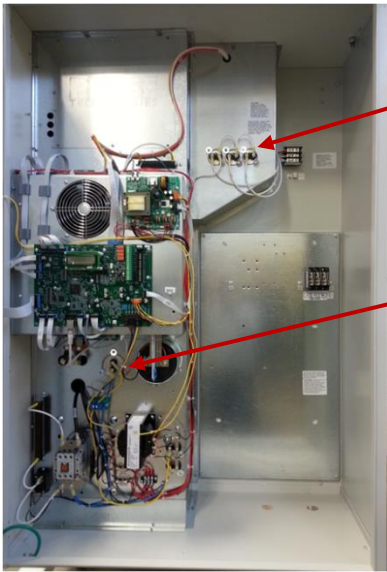

Line-to-ground capacitors for AUX POWER™ sine filter

Line-to-ground capacitors for input

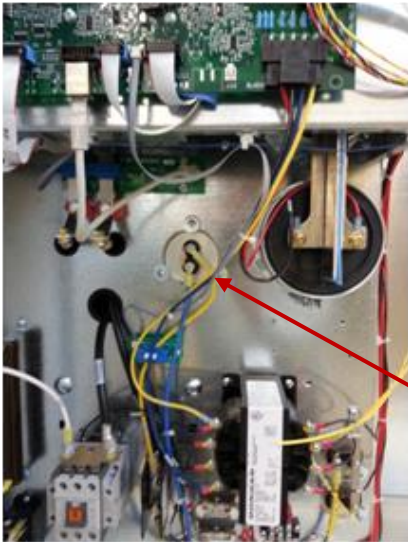

Line-to-ground capacitor for input



Line-to-ground capacitors for AUX POWER™ sine filter

Figure 27 – Line Filter Cap Location (Performance Series)

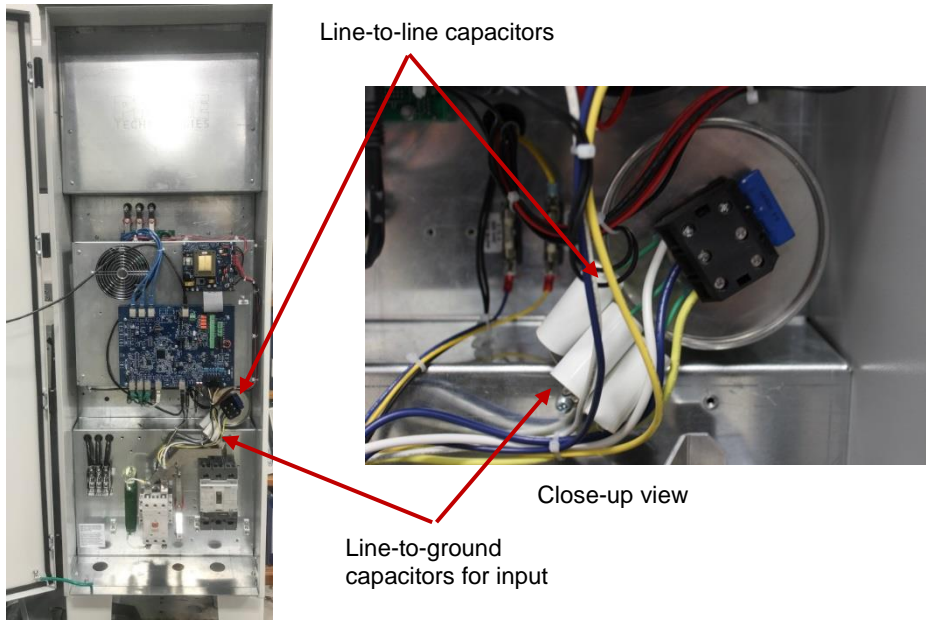

Figure 28 – Line Filter Cap Location – Signature Series

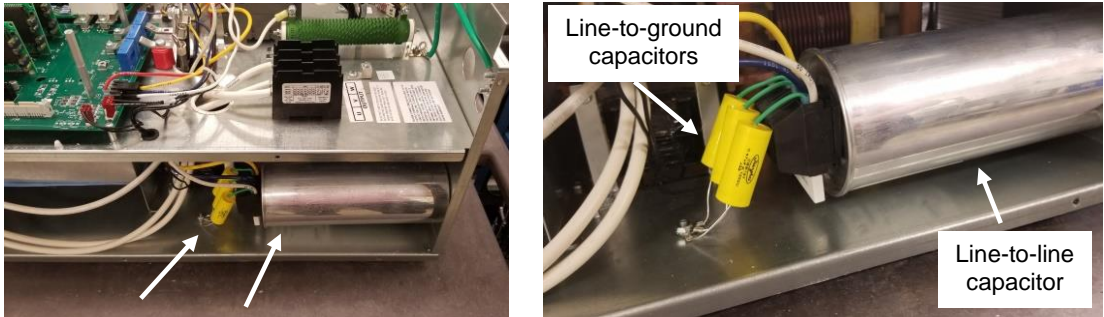

Figure 29 – Line Filter Cap Location – Enterprise Series

To access the line filter caps on the Enterprise Series, remove the left side panel. To remove left side panel, disconnect the ribbon cable from the circuit board on the inside of the door. Use a 13mm wrench to remove door hinges from left panel. Remove the screws from the left side panel and remove panel.

Fuses

There are several field replaceable fuses in the drive. Each fuse is assigned a designator to help identify the fuse. Replacement fuses are available from the factory by contacting Customer Service at 605-343-7934. Refer to **Table 26** for fuse ratings.

Table 26 – Fuse Ratings

Fuse Designator	Comments	480V Input Fuse Rating	240V Input Fuse Rating
F1	Secondary of control transformer. Located on power supply printed circuit board.	2A	2A
F2	Primary of control transformer. Located on power supply printed circuit board.	3.5A	3.5A
F3	Primary of control transformer	5A	5A
FS10, FS11	Protects the primary of the control transformer.	500VAC, 3.15A	250VAC, 8A



Fuses FS10 and F11 are located on the panel near the control transformer

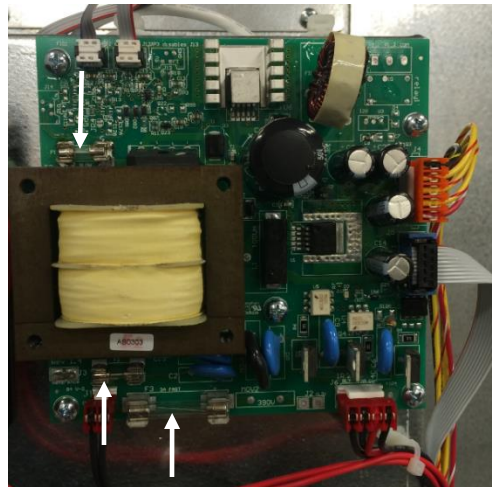

Fuses F1, F2 and F3 are located on the Power Supply printed circuit board.

Figure 30 – Fuses – Performance Series

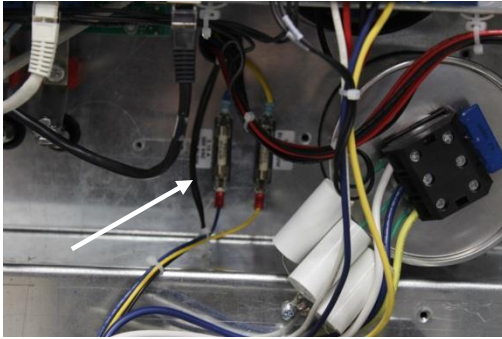

Fuses FS10 and F11 are located on the panel near the line capacitors

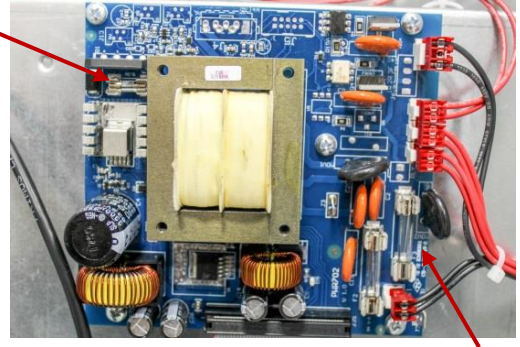

Fuses F1, F2 and F3 are located on the Power Supply printed circuit board.

Figure 31 – Fuses – Signature Series



Fuses FS10 and F11 are located on the panel near the circuit breaker.



Fuses F1 and F2 are located on the circuit board beneath the display.

Figure 32 – Fuses – Enterprise Series

Battery

The drive is equipped with a battery that provides power to a real-time clock. The clock allows faults to be stamped with time and date. The battery is located on the control printed circuit board. It is a button cell lithium battery rated at 3.0V, type CR2032. The battery should last many years under normal operating conditions. If the battery fails, the drive will continue to operate normally; losing only the ability to timestamp faults and provides timed operation of programmable relays.

9 MODELS AND RATINGS

9.1 Model Nomenclature

1LH Performance Series Example Part Number: 1LH1220R-B110FS | 1LH1420R-B110S OPTIONAL UL508A Panel Shop Integration

Model Series	Input / Output Voltage	Rated HP	Enclosure Rating	AUXILIARY Power Converter	Branch Circuit Protection	Add'l. User Controls	Output Filter	Surge Protection	Torque Control	Modbus	Torque Control & Modbus
1LH SERIES	2 240 V 480 V Phase Converting Voltage Doubling	20 - 20 HP 30 - 30 HP 40 - 40 HP 50 - 50 HP	R 3R Rated Outdoor Type Rain / Bug Proof	C - 15A Not available for: 1LH1220R X - 32A Not available for: 1LH240R, 1LH250R, 1LH4100R & 1LH4220R	B MCCB Service Disconnect	Choose Option H - I/OA Switch & Speed Pot H1 - HOA Switch Only H2 - Speed Pot Only	Choose Option O - Sinewave Filter OF - dV/dt Filter	Choose Option S Strikesorb® Surge Protection	V1 Torque Control Industrial / Oil Gas Applications	V2 Modbus Industrial / Oil Gas Applications	V3* Torque Control & Modbus Industrial / Oil Gas Applications
	4 480 V 480 V Phase Converting	20 - 20 HP 30 - 30 HP 40 - 40 IIP 50 - 50 HP 60 - 60 HP 75 - 75 HP 100 - 100 HP 125 - 125 HP									

* Option "V3" includes both Torque Control & Modbus - do not add V1 or V2 when using this option

Figure 33 – 1LH (Performance) Series Nomenclature

1LHS Signature Series Example Part Number: 1LHS220R-BH0S | 1LHS420R-BH0S OPTIONAL UL508A Panel Shop Integration

Model Series	Input / Output Voltage	Rated HP	Enclosure Rating	Branch Circuit Protection	Add'l. User Controls	Output Filter	Surge Protection	Torque Control	Modbus	Torque Control & Modbus
1LHS SERIES	2 240 V 480 V Phase Converting Voltage Doubling	20 - 20 HP 30 - 30 HP 40 - 40 HP	R 3R Rated Outdoor Type Rain / Bug Proof	B MCCB Service Disconnect	Choose Option H - I/OA Switch & Speed Pot H1 - HOA Switch Only H2 - Speed Pot Only	Choose Option O - Sinewave Filter OF - dV/dt Filter	Choose Option S Strikesorb® Surge S1 - Protect® Surge	V1 Torque Control Industrial / Oil Gas Applications	V2 Modbus Industrial / Oil Gas Applications	V3* Torque Control & Modbus Industrial / Oil Gas Applications
	4 480 V 480 V Phase Converting	20 - 20 HP 30 - 30 HP 40 - 40 HP 50 - 50 HP 60 - 60 HP 75 - 75 HP 100 - 100 HP								

* Option "V3" includes both Torque Control & Modbus - do not add V1 or V2 when using this option

Figure 34 – 1LHS (Signature) Series Nomenclature

1LHE SERIES Example Part Number: 1LHE005R-BH0S | 1LHE205R-BH0S | 1LHE405R-BH0S OPTIONAL UL508A Panel Shop Integration

Model Series	Input / Output Voltage	Rated HP	Enclosure Rating	Branch Circuit Protection	Add'l. User Controls	Output Filter	Surge Protection	Torque Control	Modbus
1LHE SERIES	0 240 V 240 V Phase Converting	05 - 5 HP 07 - 7.5 HP 10 - 10 HP 15 - 15 HP 20* - 20 HP	R 3R Rated Outdoor Type Rain / Bug Proof	B MCCB Service Disconnect	Optional User-Installed Choose Option H - HOA Switch & Speed Pot H1 - HOA Switch Only H2 - Speed Pot Only	Optional User-Installed Sinewave Filter	Optional User-Installed Choose Option S - Strikesorb® Surge S1 - Protect® Surge	V1 Torque Control Industrial / Oil Gas Applications	V2 Modbus Industrial / Oil Gas Applications
	2 240 V 480 V Phase Converting Voltage Doubling	05 - 5 HP 07 - 7.5 HP 10 - 10 HP 15 - 15 HP 20 - 20 HP 25* - 25 HP							
	4 480 V 480 V Phase Converting	05 - 5 HP 07 - 7.5 HP 10 - 10 HP 15 - 15 HP 20 - 20 HP 25 - 25 HP 30 - 30 HP							

*Not available for: 1LHE005R or 1LHE005S

Figure 35 – 1LHE (Enterprise) Series Nomenclature

Model Series	Input / Output Voltage	Rated HP	Enclosure Rating	Branch Circuit Protection	Adtl. User Controls	Output Filter	Surge Protection	Torque Control	Modbus	Torque Control & Modbus
1DXS SERIES	4 480 V 480 V Phase Converting Three Phase	20 - 20 HP 30 - 30 HP 40 - 40 HP 50 - 50 HP 60 - 60 HP 75 - 75 HP	R 3R Rated Outdoor Type Rain / Bug Proof	B MCCB Service Disconnect	Choose Option H - HOA Switch & Speed Pot H1 - HOA Switch Only H2 - Speed Pot Only	Choose Option O - Sinewave Filter OF - dv/dt Filter	Choose Option S - Strikesorb* Surge Protection S1 - Protec* Surge Protection	V1 Torque Control <small>Industrial / Oil-Gas Applications</small>	V2 Modbus <small>Industrial / Oil Gas Applications</small>	V3* Torque Control & Modbus <small>Industrial / Oil-Gas Applications</small>

Figure 36 – 1DXS Series Nomenclature

Model Series	Input / Output Voltage	Rated HP	Enclosure Rating	Branch Circuit Protection	Output Filter	Surge Protection
SDE SERIES	0 240V 240V Phase Converting	07 - 7.5 HP 10 - 10 HP 15* - 15 HP	R 3R Rated Outdoor Type Rain / Bug Proof	B MCCB Service Disconnect	Not Available O Sinewave Filter	S Strikesorb Surge Protection
	4 480V 480V Phase Converting	05 - 5 HP 07 - 7.5 HP 10 - 10 HP 15** - 15 HP				

*Transducer included with all models - except SDE015R
 **MCCB Disconnect not available

Figure 37 – SDE (Enterprise) Series Nomenclature

3LH SERIES Example Part Number: 3LH220R-BHQQS | 3LH420R-BHQQSV1

OPTIONAL UL508A Panel Shop Integration

Model Series	Input / Output Voltage	Rated HP	Enclosure Rating	Branch Circuit Protection	Add. User Controls	Output Filter	System Bypass	Surge Protection	Torque Control	Modbus	Torque Control & Modbus		
3LH SERIES	2 240V 480V Three Phase Voltage Doubling	20 - 20 HP	R 3R Rated Outdoor Type Rain / Bug Proof	B MCCB Service Disconnect	Choose Option H - HOA Switch & Speed Pot H1 - HOA Switch Only H2 - Speed Pot Only	Choose Option O - Sinewave Filter OF - dV/dt Filter <small>Note: Only available up to 150 HP</small>	Q System Bypass <small>Not Available for 3LH420R-BHQQSV1</small>	S Strikesorb® Surge Protection	V1 Torque Control (optional) <small>Oil Gas Applications</small>	V2 Modbus (optional) <small>Oil Gas Applications</small>	V3' Torque Control & Modbus (optional) <small>Oil Gas Applications</small>		
		30 - 30 HP										40 - 40 HP	50 - 50 HP
	4 480V 480V Three Phase	20 - 20 HP											
		30 - 30 HP	40 - 40 HP	50 - 50 HP	60 - 60 HP	75 - 75 HP	100 - 100 HP	125 - 125 HP	150 - 150 HP	200 - 200 HP	250 - 250 HP	300 - 300 HP	350 - 350 HP

* Option 'V1' includes both Torque Control & Modbus - do not add 'V1' or 'V2' when using this option

Figure 38 – 3LH (Performance) Series Nomenclature

3LHS SERIES Example Part Number: 3LHS220R-BH10S | 3LHS420R-BH10SV1

OPTIONAL UL508A Panel Shop Integration

Model Series	Input / Output Voltage	Rated HP	Enclosure Rating	Branch Circuit Protection	Add. User Controls	Output Filter	Surge Protection	Torque Control	Modbus	Torque Control & Modbus
3LHS SERIES	2 240V 480V Three Phase Voltage Doubling	20 - 20 HP	R 3R Rated Outdoor Type Rain / Bug Proof	B MCCB Service Disconnect	Choose Option H - HOA Switch & Speed Pot H1 - HOA Switch Only H2 - Speed Pot Only	Choose Option O - Sinewave Filter OF - dV/dt Filter <small>Note: Only available up to 150 HP</small>	S Strikesorb® Surge Protection S1 - Protec® Surge Protection	V1 Torque Control (optional) <small>Oil Gas Applications</small>	V2 Modbus (optional) <small>Oil Gas Applications</small>	V3' Torque Control & Modbus (optional) <small>Oil Gas Applications</small>
		30 - 30 HP								
	4 480V 480V Three Phase	20 - 20 HP								
		30 - 30 HP	40 - 40 HP	50 - 50 HP	60 - 60 HP	75 - 75 HP	100 - 100 HP	125 - 125 HP	150 - 150 HP	200 - 200 HP

* Option 'V2' includes both Torque Control & Modbus - do not add 'V1' or 'V2' when using this option

Figure 39 – 3LHS (Signature) Series Nomenclature

3LHE SERIES Example Part Number: 3LHE00SR-BHOS | 3LHE20SR-BHOS | 3LHE40SR-BHOS

OPTIONAL UL508A Panel Shop Integration

Model Series	Input / Output Voltage	Rated HP	Enclosure Rating	Branch Circuit Protection	Add. User Controls	Output Filter	Surge Protection	Torque Control	Modbus
3LHE SERIES	0 240V 240V Three-Phase	05 - 5 HP	R 3R Rated Outdoor Type Rain / Bug Proof	B MCCB Service Disconnect	Optional User-Installed H - HOA Switch & Speed Pot H1 - HOA Switch Only H2 - Speed Pot Only	O Sinewave Filter <small>*Not Available for 3LHE00SR-BHOS, 3LHE20SR-BHOS, 3LHE40SR-BHOS</small>	Optional User-Installed S - Strikesorb® Surge Protection S1 - Protec® Surge Protection	V1 Torque Control (optional) <small>Oil Gas Applications</small>	V2 Modbus (optional) <small>Oil Gas Applications</small>
		07 - 7.5 HP							
	2 240V 480V Three Phase Voltage Doubling	05 - 5 HP							
		07 - 7.5 HP	10 - 10 HP	15 - 15 HP	20 - 20 HP	25 - 25 HP			
	4 480V 480V Three-Phase	05 - 5 HP							
		07 - 7.5 HP	10 - 10 HP	15 - 15 HP	20 - 20 HP	25 - 25 HP	30 - 30 HP	40* - 40 HP	50* - 50 HP

Figure 40 – 3LHE (Enterprise) Series Nomenclature

Model Series	Input / Output Voltage	Rated HP	Enclosure Rating	Branch Circuit Protection	Addl. User Controls	Output Filter	System Bypass	Surge Protection	Torque Control	Modbus	Torque Control & Modbus
DX SERIES	4 480 V 480 V Three Phase	20 - 20 HP 30 - 30 HP 40 - 40 HP 50 - 50 HP 60 - 60 HP 75 - 75 HP 100 - 100 HP 125 - 125 HP 150 - 150 HP 200 - 200 HP 250 - 250 HP 300 - 300 HP 350 - 350 HP 400 - 400 HP ¹ 450 - 450 HP ¹ 500 - 500 HP	R 3R Rated Outdoor Type Rain / Bug Proof	B MCCB Service Disconnect	Choose Option H - HOA Switch & Speed Pot H1 - HOA Switch Only H2 - Speed Pot Only	Choose Option O - Sinewave Filter OF - dV/dt Filter <small>(UL508A & UL508B, 300V)</small>	Q System Bypass <small>(UL508A & UL508B, 300V)</small>	Choose Option S - Strikesorb [®] Surge Protection S1 - Protec [®] Surge Protection	V1 Torque Control Industrial / Oil Gas Applications	V2 Modbus Industrial / Oil Gas Applications	V3* Torque Control & Modbus Industrial / Oil Gas Applications

Figure 41 – DX (Performance) Series Nomenclature

Model Series	Input / Output Voltage	Rated HP	Enclosure Rating	Branch Circuit Protection	Addl. User Controls	Output Filter	Surge Protection	Torque Control	Modbus	Torque Control & Modbus
DXS SERIES	4 480 V 480 V Three Phase	20 - 20 HP 30 - 30 HP 40 - 40 HP 50 - 50 HP 60 - 60 HP 75 - 75 HP 100 - 100 HP 125 - 125 HP 150 - 150 HP 200 - 200 HP	R 3R Rated Outdoor Type Rain / Bug Proof	B MCCB Service Disconnect	Choose Option H - HOA Switch & Speed Pot H1 - HOA Switch Only H2 - Speed Pot Only	Choose Option O - Sinewave Filter OF - dV/dt Filter <small>(UL508A & UL508B, 300V)</small>	Choose Option S - Strikesorb [®] Surge Protection S1 - Protec [®] Surge Protection	V1 Torque Control Industrial / Oil Gas Applications	V2 Modbus Industrial / Oil Gas Applications	V3* Torque Control & Modbus Industrial / Oil Gas Applications

Figure 42 – DXS (Signature) Nomenclature

Model Series	Input / Output Voltage	Rated I/HP	Enclosure Rating	Branch Circuit Protection	Addl. User Controls	Input Reactor	Output Filter	Surge Protection	Torque Control	Modbus
DXE SERIES	0 240 V 240 V Three Phase	05 - 5 HP 07 - 7.5 HP 10 - 10 HP 15 - 15 HP 20 - 20 HP 25 - 25 HP 30 - 30 HP	R 3R Rated Outdoor Type Rain / Bug Proof	B MCCB Service Disconnect	Choose Option H - HOA Switch & Speed Pot H1 - HOA Switch Only H2 - Speed Pot Only	I Input Reactor <small>(UL508A & UL508B, 300V)</small>	Choose Option O - Sinewave Filter OF - dV/dt Filter <small>(UL508A & UL508B, 300V)</small>	Choose Option S - Strikesorb [®] Surge Protection S1 - Protec [®] Surge Protection	V1 Torque Control Industrial / Oil Gas Applications	V2 Modbus Industrial / Oil Gas Applications
	4 480 V 480 V Three Phase	05 - 5 HP 07 - 7.5 HP 10 - 10 HP 15 - 15 HP 20 - 20 HP 25 - 25 HP 30 - 30 HP 40 - 40 HP 50 - 50 HP				<small>(UL508A & UL508B, 300V)</small>				

Figure 43 – DXE (Enterprise) Series Nomenclature

9.2 Model Ratings

Table 27 – 1LH Ratings

1LH Performance Series							
Model	Rated HP/kW	Rated Input Voltage	Rated Output Voltage	Rated Input Current	Rated Output Current*	Switching Frequency**	Weight†
1LH220R	20/15	240 V, 1-phase	480 V, 3-phase	97 A	31 A	2-5 kHz	490 lbs
1LH220R w/ AUXPOWER –C	---			149 A	18 A	---	510 lbs
1LH220R w/ AUXPOWER –X				191 A	32 A		740 lbs
1LH230R	30/22			139 A	46 A	2-5 kHz	540 lbs
1LH230R w/ AUXPOWER –C	---			191 A	18 A	---	760 lbs
1LH230R w/ AUXPOWER –X				252 A	32 A		770 lbs
1LH240R	40/30			196 A	61 A	2-5 kHz	810 lbs
1LH240R w/ AUXPOWER –C	---			248 A	18 A	---	840 lbs
1LH250R	50/37			226 A	77 A	2-5 kHz	910 lbs
1LH420R	20/15			48 A	31 A		570 lbs
1LH420R w/ AUXPOWER –C	---	74 A	18 A	---	590 lbs		
1LH420R w/ AUXPOWER –X		98 A	32 A		590 lbs		
1LH430R	30/22	72 A	46 A	2-5 kHz	570 lbs		
1LH430R w/ AUXPOWER –C	---	98 A	18 A	---	590 lbs		
1LH430R w/ AUXPOWER –X		124 A	32 A		590 lbs		
1LH440R	40/30	98 A	61 A	2-5 kHz	580 lbs		
1LH440R w/ AUXPOWER –C	---	124 A	18 A	---	600 lbs		
1LH440R w/ AUXPOWER –X		147 A	32 A		600 lbs		
1LH450R	50/37	121 A	77 A	2-5 kHz	590 lbs		

1LH450R w/ AUXPOWER –C	---	480 V, 1-phase	480 V, 3-phase	147 A	18 A	---	610 lbs
1LH450R w/ AUXPOWER –X	---			169 A	32 A	---	610 lbs
1LH460R	60/45			143 A	91 A	2-5 kHz	610 lbs
1LH460R w/ AUXPOWER –C	---			169 A	18 A	---	640 lbs
1LH460R w/ AUXPOWER –X	---			196 A	32 A	---	640 lbs
1LH475R	75/55			170 A	107 A	2-5 kHz	820 lbs
1LH475R w/ AUXPOWER –C	---			196 A	18 A	---	850 lbs
1LH475R w/ AUXPOWER –X	---			252 A	32 A	---	850 lbs
1LH4100R	100/75			226 A	142 A	2-5 kHz	910 lbs
1LH4100R w/ AUXPOWER –C	---			252 A	18 A	---	940 lbs
1LH4125R	125/90			273 A	172 A	2-5 kHz	925 lbs

*Rated output current for 5-75 HP models based on typical full load current for submersible motors. Rated output current for 125 HP models based on 110% of values in NEC table 430.150 Full Load Current, Three-Phase Alternating Current Motors.

**Switching Frequency is an adjustable parameter set through the keypad.

†Weight may vary based on optional equipment.

Table 28 – 1LHS Ratings

1LHS Signature Series							
Model	Rated HP/kW	Rated Input Voltage	Rated Output Voltage	Rated Input Current	Rated Output Current*	Switching Frequency**	Weight†
1LHS220R	20/15	240 V, 1-phase	480 V, 3-phase	97 A	31 A	2-5 kHz	205 lbs
1LHS230R	30/22			139 A	46 A		220 lbs
1LHS240R	40/30			196 A	61 A		465 lbs
1LHS420R	20/15	48 A		31 A	205 lbs		
1LHS430R	30/22	72 A		46 A	215 lbs		
1LHS440R	40/30	98 A		61 A	235 lbs		
1LHS450R	50/37	121 A		77 A	250 lbs		
1LHS460R	60/45	143 A		91 A	410 lbs		
1LHS475R	75/55	170 A		107 A	415 lbs		
1LHS4100R	100/75	226 A		142 A	465 lbs		

*Rated output current for 5-75 HP models based on typical full load current for submersible motors. Rated output current for 125 HP models based on 110% of values in NEC table 430.150 Full Load Current, Three-Phase Alternating Current Motors.

**Switching Frequency is an adjustable parameter set through the keypad.

†Weight may vary based on optional equipment.

Table 29 – 1LHE Ratings

1LHE Enterprise Series							
Model	Rated HP/kW	Rated Input Voltage	Rated Output Voltage	Rated Input Current	Rated Output Current*	Switching Frequency**	Weight†
1LHE005R	5/4	240 V, 1-phase	240 V, 3-phase	26 A	18 A	2-5 kHz	95 lbs
1LHE007R	7.5/5			37 A	24 A		110 lbs
1LHE010R	10/7.5			48 A	31 A		130 lbs
1LHE015R	15/11			72 A	46 A		130 lbs
1LHE020R	20/15			97 A	61 A		130 lbs
1LHE205R	5/4		480 V, 3-phase	26 A	9 A		95 lbs
1LHE207R	7.5/5			37 A	13 A		95 lbs
1LHE210R	10/7.5			50 A	18 A		100 lbs
1LHE215R	15/11			67 A	24 A		115 lbs
1LHE220R	20/15			97 A	31 A		150 lbs
1LHE225R	25/18.5	115 A		40 A	150 lbs		
1LHE405R	5/4	480 V, 1-phase		13 A	9 A		100 lbs
1LHE407R	7.5/5			19 A	13 A		100 lbs
1LHE410R	10/7.5			26 A	18 A		100 lbs
1LHE415R	15/11			36 A	24 A	130 lbs	
1LHE420R	20/15		48 A	31 A	130 lbs		
1LHE425R	25/18.5		60 A	40 A	130 lbs		
1LHE430R	30/22		72 A	46 A	130 lbs		

*Rated output current for 5-75 HP models based on typical full load current for submersible motors. Rated output current for 125 HP models based on 110% of values in NEC table 430.150 Full Load Current, Three-Phase Alternating Current Motors.

**Switching Frequency is an adjustable parameter set through the keypad.

†Weight may vary based on optional equipment.

Table 30 – 1DXS Series

1DXS Signature Series							
Model	Rated HP/kW	Rated Input Voltage	Rated Output Voltage	Rated Input Current	Rated Output Current*	Switching Frequency**	Weight†
1DXS420	20/10	480V, 1-phase	480 V, 3-phase	61 A	31 A	2-5 kHz	220 lbs
1DXS430	30/20			91 A	46 A		255 lbs
1DXS440	40/25			122 A	61 A		290 lbs
1DXS450	50/35			142 A	77 A		310 lbs
1DXS460	60/40			182 A	91 A		425 lbs
1DXS475	75/55			198 A	107 A		450 lbs

Table 31 – SDE Ratings

DXE Signature Series							
Model	Rated HP/kW	Rated Input Voltage	Rated Output Voltage	Rated Input Current	Rated Output Current*	Switching Frequency**	Weight†
SDE007R	7.5/5	240 V, 1-Phase	240 V, 3-Phase	58 A	27 A	2-5 kHz	95 lbs
SDE010R	10/7.5			69 A	33 A		110 lbs
SDE015R	15/11			92 A	46 A		120 lbs
SDE405R	5/4	480 V, 1-Phase	480 V, 3-Phase	30 A	10 A		100 lbs
SDE407R	7/5			37 A	13 A		95 lbs
SDE410R	10/7.5			42 A	18 A		110 lbs
SDE415R	15/11			56 A	25 A	120 lbs	

*Rated output current for 5-75 HP models based on typical full load current for submersible motors. Rated output current for 125 HP models based on 110% of values in NEC table 430.150 Full Load Current, Three-Phase Alternating Current Motors

**Switching Frequency is an adjustable parameter set through the keypad.

†Weight may vary based on optional equipment.

Table 32 – 3LH Ratings

3LH Performance Series							
Model	Rated HP/kW	Rated Input Voltage	Rated Output Voltage	Rated Input Current	Rated Output Current*	Switching Frequency**	Weight†
3LH220R	20/15	480 V, 3-phase	480 V, 3-phase	61 A	31 A	2-5 kHz	450 lbs
3LH230R	30/22			91 A	46 A		615 lbs
3LH240R	40/30			121 A	61 A		630 lbs
3LH250R	50/37			142 A	77 A		645 lbs
3LH260R	60/45			172 A	91 A		810 lbs
3LH420R	20/15			31 A			445 lbs
3LH430R	30/22			46 A			445 lbs
3LH440R	40/30			61 A			450 lbs
3LH450R	50/37			77 A			450 lbs
3LH460R	60/45			91 A			615 lbs
3LH475R	75/55			107 A			620 lbs
3LH4100R	100/75			142 A			645 lbs
3LH4125R	125/90			172 A			810 lbs
3LH4150R	150/110			198 A			890 lbs
3LH4200R	200/150			250 A			935 lbs
3LH4250R	250/185			304 A			950 lbs
3LH4300R	300/220			362 A			980 lbs
3LH4350R	350/260			415 A			1,050 lbs
3LH4400R	400/299			478 A			1,320 lbs
3LH4450R	450/336			515 A			1,330 lbs

Table 33 – 3LHS Ratings

3LHS Signature Series							
Model	Rated HP/kW	Rated Input Voltage	Rated Output Voltage	Rated Input Current	Rated Output Current*	Switching Frequency**	Weight†
3LHS220R	20/15	240 V, 3-phase	480 V, 3-phase	61 A	31 A	2-5 kHz	220 lbs
3LHS230R	30/22			91 A	46 A		340 lbs
3LHS240R	40/30			121 A	61 A		370 lbs
3LHS250R	50/37			142 A	77 A		480 lbs
3LHS260R	60/45			172 A	91 A		530 lbs
3LHS420R	20/15	480 V, 3-phase		31 A	180 lbs		
3LHS430R	30/22			46 A	210 lbs		
3LHS440R	40/30			61 A	215 lbs		
3LHS450R	50/37			77 A	220 lbs		
3LHS460R	60/45			91 A	375 lbs		
3LHS475R	75/55			107 A	380 lbs		
3LHS4100R	100/75			142 A	385 lbs		
3LHS4125R	125/90			172 A	475 lbs		
3LHS4150R	150/110			198 A	480 lbs		
3LHS4200R	200/150			250 A	540 lbs		

*Rated output current for 5-75 HP models based on typical full load current for submersible motors. Rated output current for 125 HP models based on 110% of values in NEC table 430.150 Full Load Current, Three-Phase Alternating Current Motors.

**Switching Frequency is an adjustable parameter set through the keypad.

†Weight may vary based on optional equipment.

Table 34 – 3LHE Ratings

3LHE Enterprise Series								
Model	Rated HP/KW	Rated Input Voltage	Rated Output Voltage	Rated Input Current	Rated Output Current*	Switching Frequency**	Weight†	
3LHE005R	5/4	240 V, 3-phase	240 V, 3-phase	18 A		2-5 kHz	95 lbs	
3LHE007R	7/5			24 A			110 lbs	
3LHE010R	10/7.5			31 A			140 lbs	
3LHE015R	15/11			46 A			140 lbs	
3LHE020R	20/15			61 A			140 lbs	
3LHE025R	25/18.5			75 A			150 lbs	
3LHE030R	30/22			91 A			150 lbs	
3LHE205R	5/4		480 V, 3-phase	480 V, 3-phase	18 A		9 A	100 lbs
3LHE207R	7/5				24 A		13 A	100 lbs
3LHE210R	10/7.5				30 A		18 A	130 lbs
3LHE215R	15/11				46 A		24 A	140 lbs
3LHE220R	20/15				61 A		31 A	160 lbs
3LHE225R	25/18.5				77 A		38 A	160 lbs
3LHE405R	5/4				9 A		100 lbs	
3LHE407R	7/6	13 A			100 lbs			
3LHE410R	10/8	18 A			100 lbs			
3LHE415R	15/11	24 A			130 lbs			
3LHE420R	20/14	31 A			150 lbs			
3LHE425R	25/17	38 A			150 lbs			
3LHE430R	30/21	46 A			150 lbs			
3LHE440R	40/28	61 A			160 lbs			
3LHE450R	50/37	77 A		160 lbs				

*Rated output current for 5-75 HP models based on typical full load current for submersible motors. Rated output current for 125 HP models based on 110% of values in NEC table 430.150 Full Load Current, Three-Phase Alternating Current Motors

**Switching Frequency is an adjustable parameter set through the keypad.

†Weight may vary based on optional equipment.

Table 35 – DX Ratings

DX Performance Series						
Model	Rated HP/kW	Rated Input Voltage	Rated Output Voltage	Rated Input/Output Current*	Switching Frequency**	Weight†
DX420R	20/15	480 V, 3-phase	480 V, 3-phase	31 A	2-5 kHz	420 lbs
DX430R	30/22			46 A		445 lbs
DX440R	40/30			61 A		450 lbs
DX450R	50/37			77 A		455 lbs
DX460R	60/45			91 A		605 lbs
DX475R	75/56			107 A		615 lbs
DX4100R	100/75			142 A		635 lbs
DX4125R	125/93			172 A		640 lbs
DX4150R	150/112			198 A		805 lbs
DX4200R	200/150			250 A		910 lbs
DX4250R	250/185			304 A		925 lbs
DX4300R	300/220			362 A		930 lbs
DX4350R	350/260			415 A		1,100 lbs
DX4400R	400/299			478 A		1,240 lbs
DX4450R	450/336			515 A		1,290 lbs

*Rated output current for 5-75 HP models based on typical full load current for submersible motors. Rated output current for 125 HP models based on 110% of values in NEC table 430.150 Full Load Current, Three-Phase Alternating Current Motors.

**Switching Frequency is an adjustable parameter set through the keypad.

†Weight may vary based on optional equipment.

Table 36 – DXS Ratings

DXS Signature Series						
Model	Rated HP/kW	Rated Input Voltage	Rated Output Voltage	Rated Input/Output Current*	Switching Frequency**	Weight†
DXS420R	20/15	480 V, 3-phase	480 V, 3-phase	31 A	2-5 kHz	200 lbs
DXS430R	30/22			46 A		200 lbs
DXS440R	40/30			61 A		215 lbs
DXS450R	50/37			77 A		220 lbs
DXS460R	60/45			91 A		345 lbs
DXS475R	75/55			107 A		350 lbs
DXS4100R	100/75			142 A		360 lbs
DXS4125R	125/90			172 A		440 lbs
DXS4150R	150/110			198 A		450 lbs
DXS4200R	200/150			250 A		500 lbs

*Rated output current for 5-75 HP models based on typical full load current for submersible motors. Rated output current for 125 HP models based on 110% of values in NEC table 430.150 Full Load Current, Three-Phase Alternating Current Motors.

**Switching Frequency is an adjustable parameter set through the keypad.

†Weight may vary based on optional equipment.

Table 37 – DXE Ratings

DXE Signature Series						
Model	Rated HP/kW	Rated Input Voltage	Rated Output Voltage	Rated Input/Output Current*	Switching Frequency**	Weight†
DXE005R	5/4	240 V, 3-phase	240 V, 3-phase	18 A	2-5 kHz	85 lbs
DXE007R	7.5/5			24 A		90 lbs
DXE010R	10/7.5			31 A		125 lbs
DXE015R	15/11			46 A		130 lbs
DXE020R	20/15			61 A		135 lbs
DXE025R	25/18.5			75 A		155 lbs
DXE030R	30/22			91 A		170 lbs
DXE405R	5/4	480 V, 3-phase	480 V, 3-phase	9 A		90 lbs
DXE407R	7/5			13 A		90 lbs
DXE410R	10/7.5			18 A		90 lbs
DXE415R	15/11			24 A		100 lbs
DXE420R	20/15			31 A		125 lbs
DXE425R	25/18.5			38 A		130 lbs
DXE430R	30/22			46 A		130 lbs
DXE440R	40/30			61 A	140 lbs	
DXE450R	50/37			77 A	160 lbs	

*Rated output current for 5-75 HP models based on typical full load current for submersible motors. Rated output current for 125 HP models based on 110% of values in NEC table 430.150 Full Load Current, Three-Phase Alternating Current Motors

**Switching Frequency is an adjustable parameter set through the keypad.

†Weight may vary based on optional equipment.

9.3 Dimensional Drawings

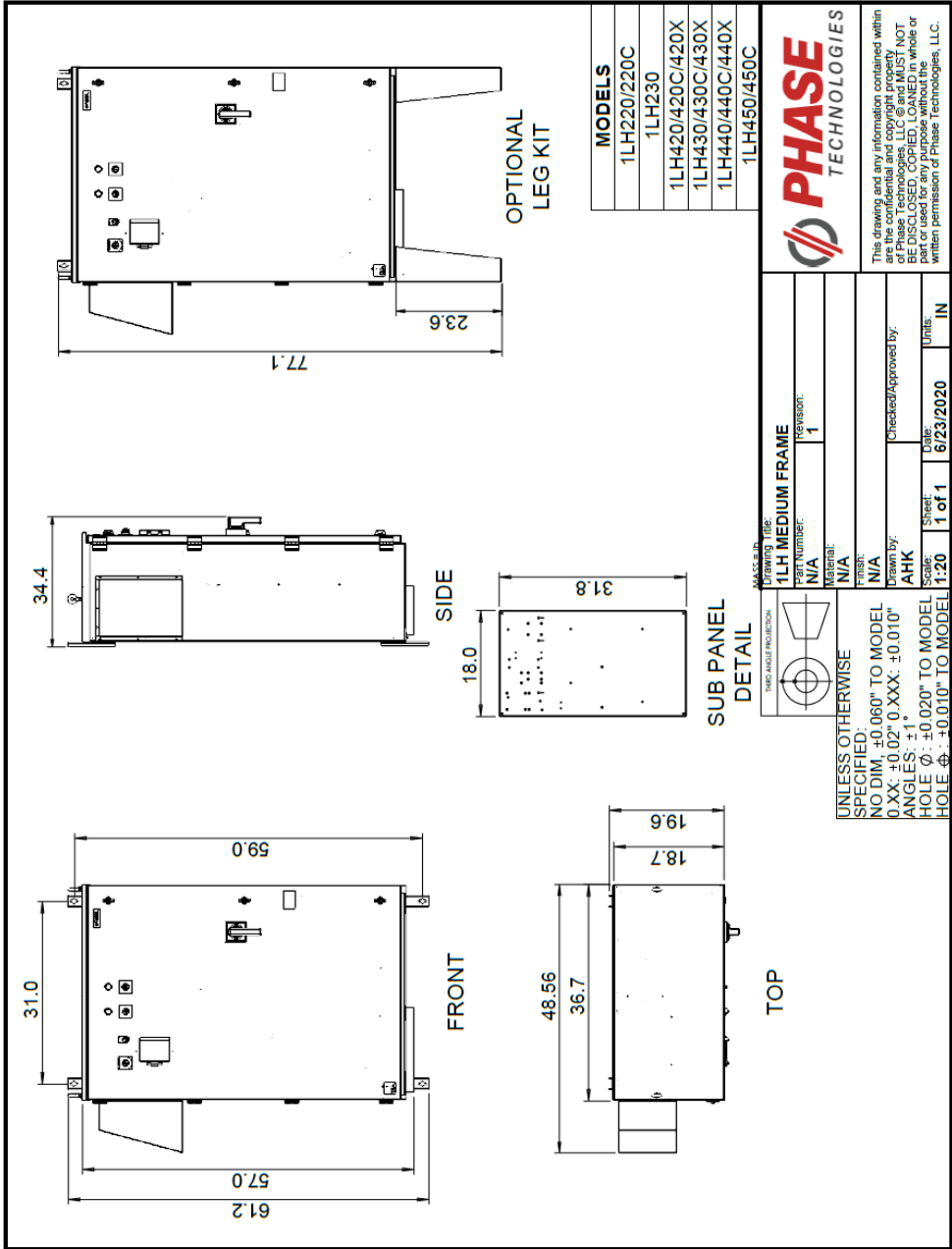

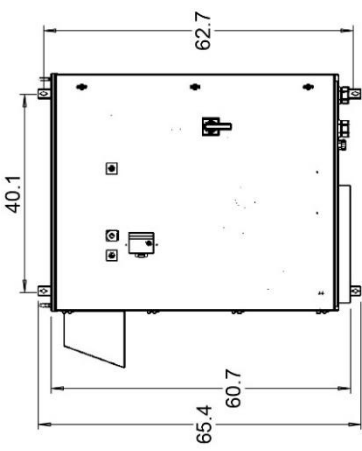

FRONT

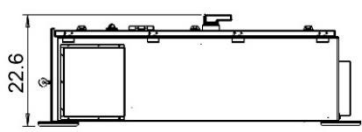

SIDE

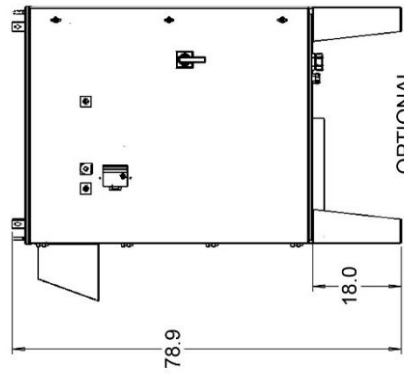

OPTIONAL LEG KIT

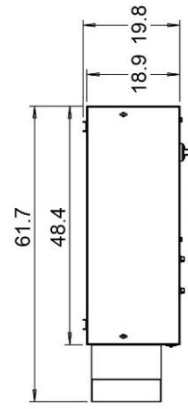

TOP

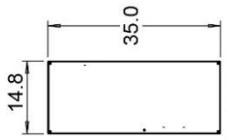

SUB PANEL DETAIL

MODELS
1LH220X
1LH230C/230X
1LH240/240C
1LH250
1LH450X
1LH460/460C/460X
1LH475/475C/475X
1LH4100/4100C
1LH4125

		1LH LARGE FRAME Revision: 3	
UNLESS OTHERWISE SPECIFIED: NO DIM: $\pm 0.060"$ TO MODEL 0.XX: $\pm 0.02"$ 0.XXX: $\pm 0.010"$ ANGLES: $\pm 1^\circ$ HOLE ϕ : $\pm 0.020"$ TO MODEL HOLE ϕ : $\pm 0.010"$ TO MODEL		Drawing Title: Part Number: Material: Finish: Drawn by: Checked/Approved by: AAR Scale: Date: 9/4/2020 Sheet: 1 of 1 Units: IN	
		This drawing and any information contained within are the confidential and copyright property of PHASE TECHNOLOGIES. IT IS NOT TO BE DISCLOSED, COPIED, LOANED in whole or part or used for any purpose without the written permission of Phase Technologies, LLC.	

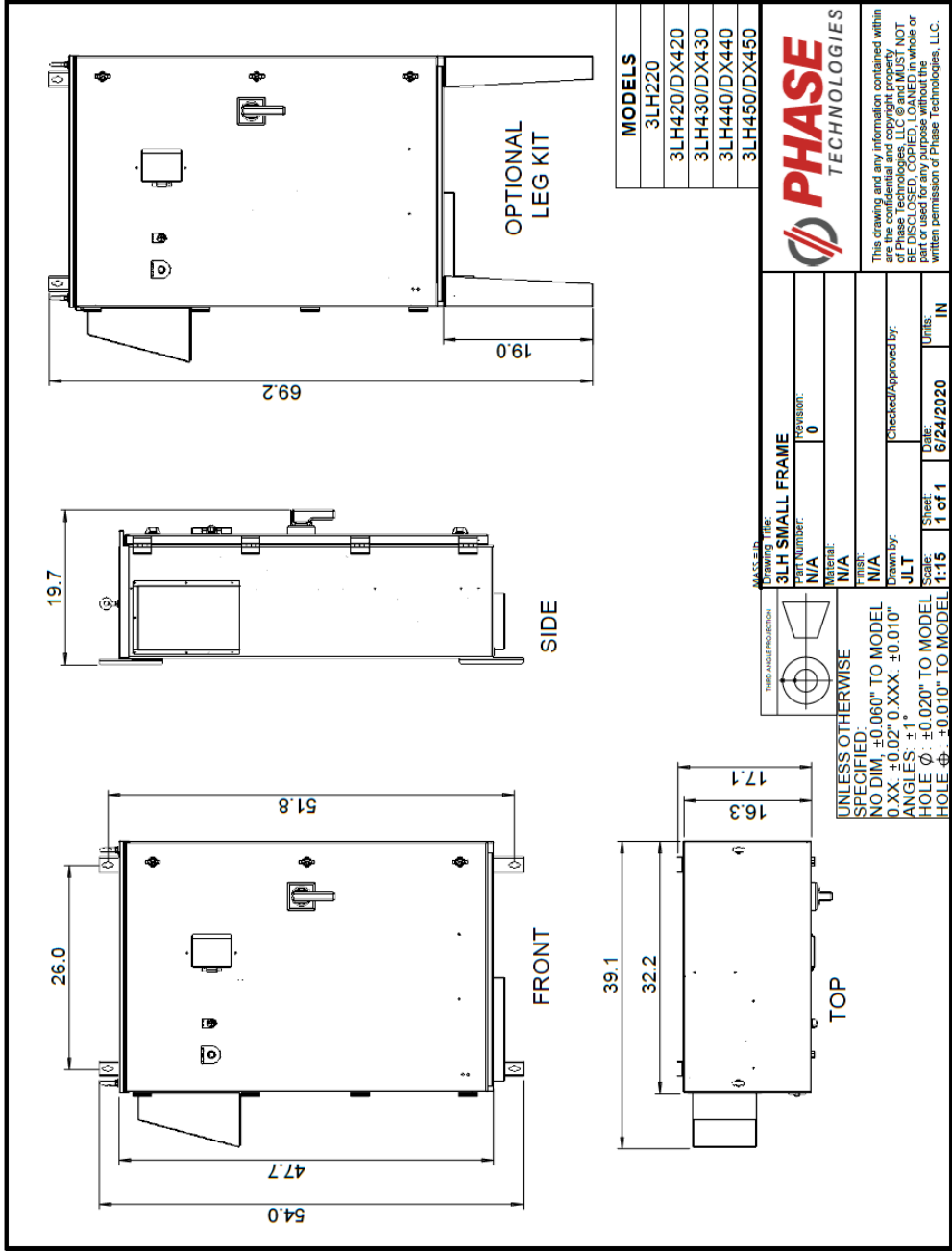

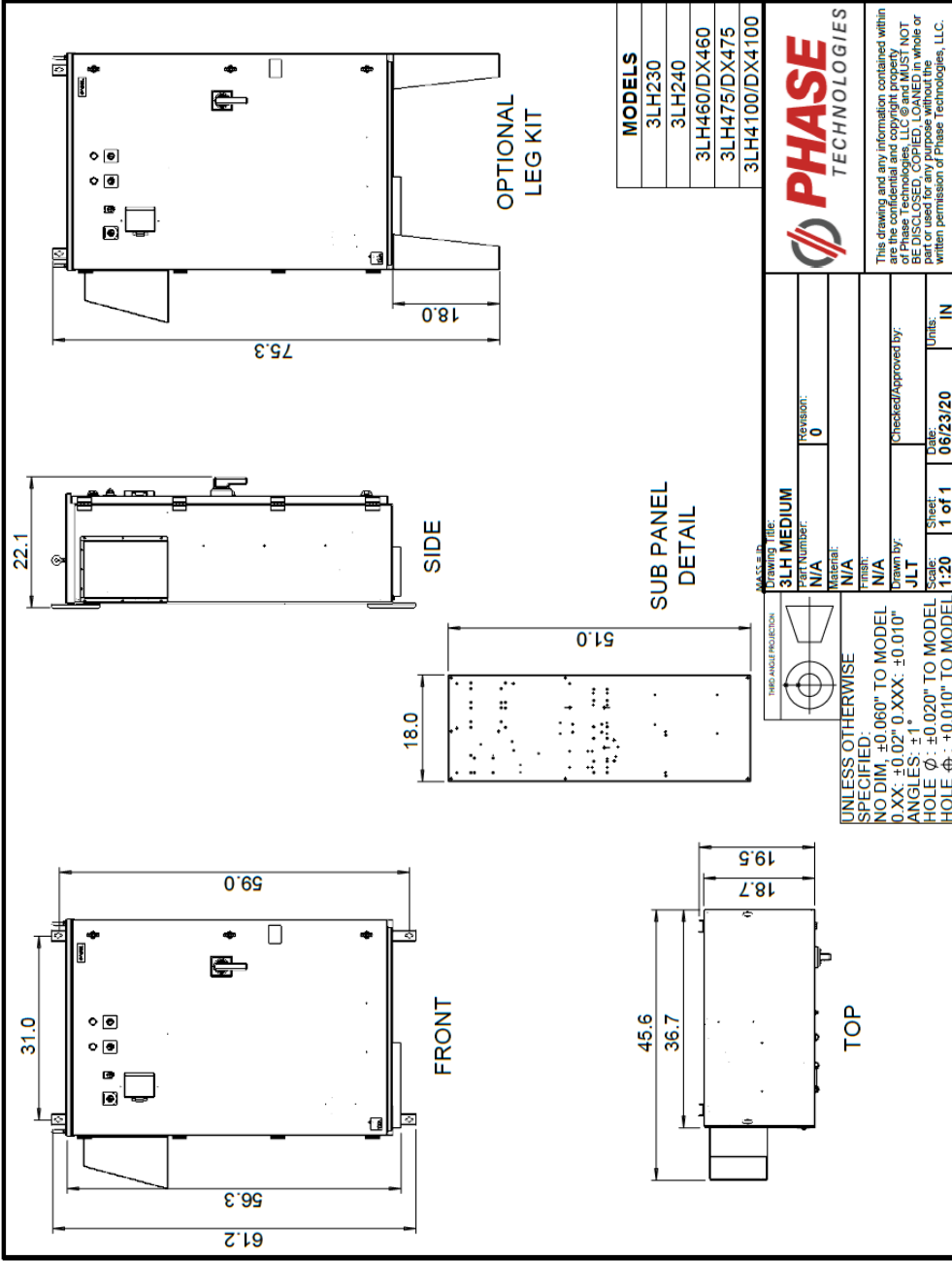

MODELS
3LH230
3LH240
3LH460/DX460
3LH475/DX475
3LH4100/DX4100



This drawing and any information contained within it is the confidential and copyrighted property of PHASE TECHNOLOGIES, LLC. IT MUST NOT BE DISCLOSED, COPIED, LOANED in whole or in part or used for any purpose without the written permission of Phase Technologies, LLC.

DRAWING TITLE: 3LH MEDIUM		REVISION: 0
PART NUMBER: N/A		
MATERIAL: N/A		
FINISH: N/A		
DRAWN BY: JLT		CHECKED/APPROVED BY:
SCALE: 1:20		DATE: 06/23/20
SHEET: 1 of 1		UNITS: IN

THIRD ANGLE PROJECTION

UNLESS OTHERWISE SPECIFIED:
 NO DIM: $\pm 0.060"$ TO MODEL
 0.XX: $\pm 0.02"$ 0.XXX: $\pm 0.010"$
 ANGLES: $\pm 1^\circ$
 HOLE \varnothing : $\pm 0.020"$ TO MODEL
 HOLE \varnothing : $\pm 0.010"$ TO MODEL

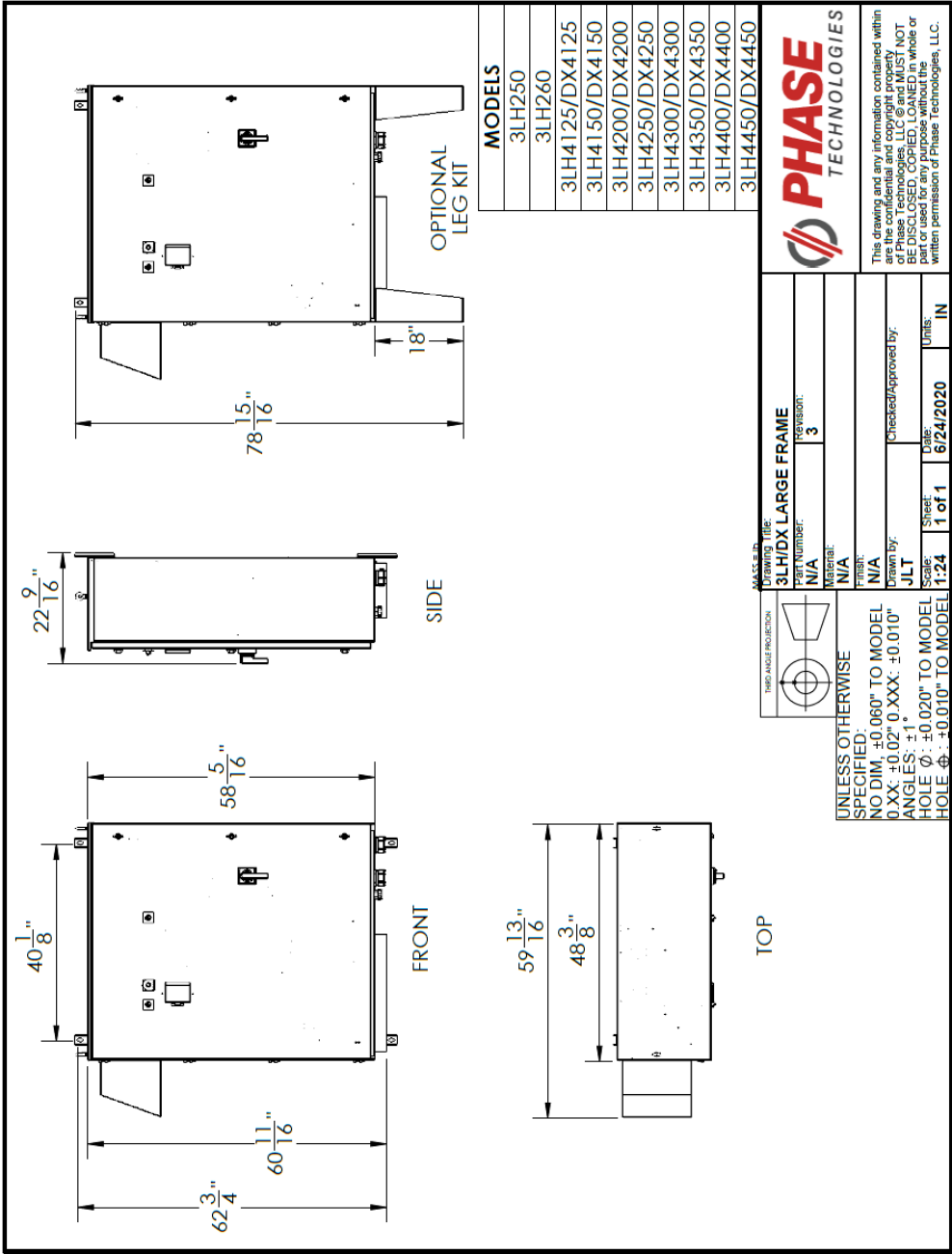

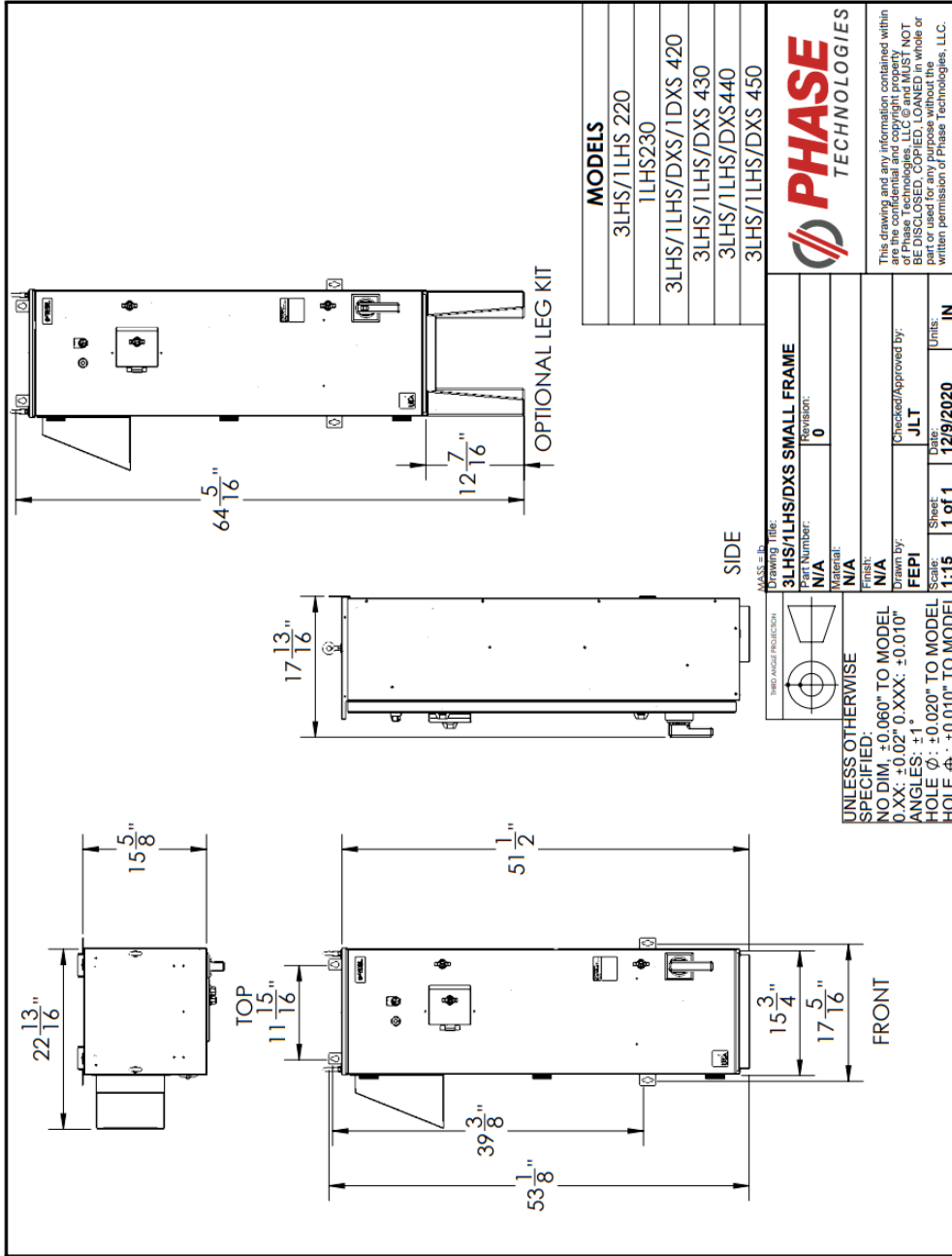

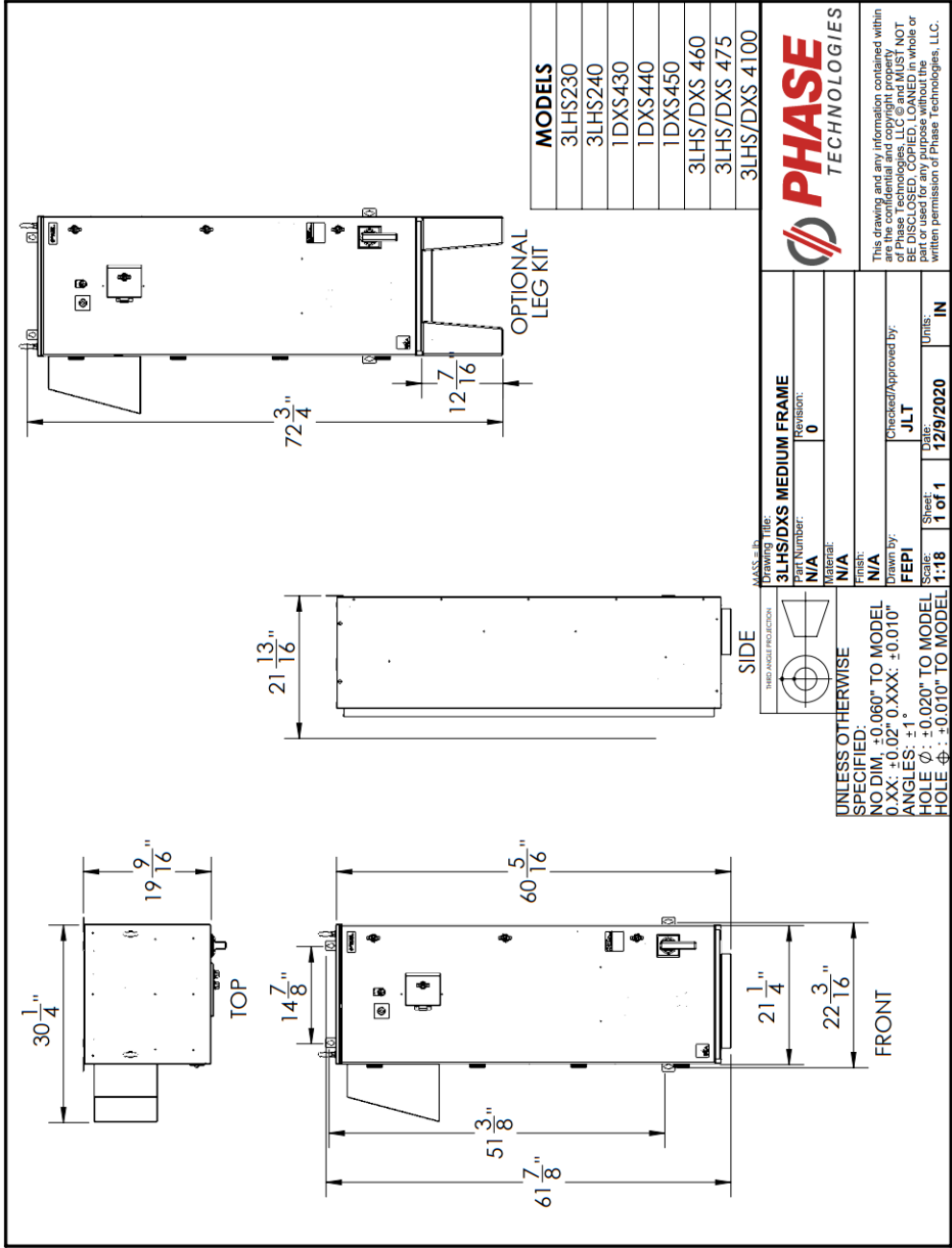

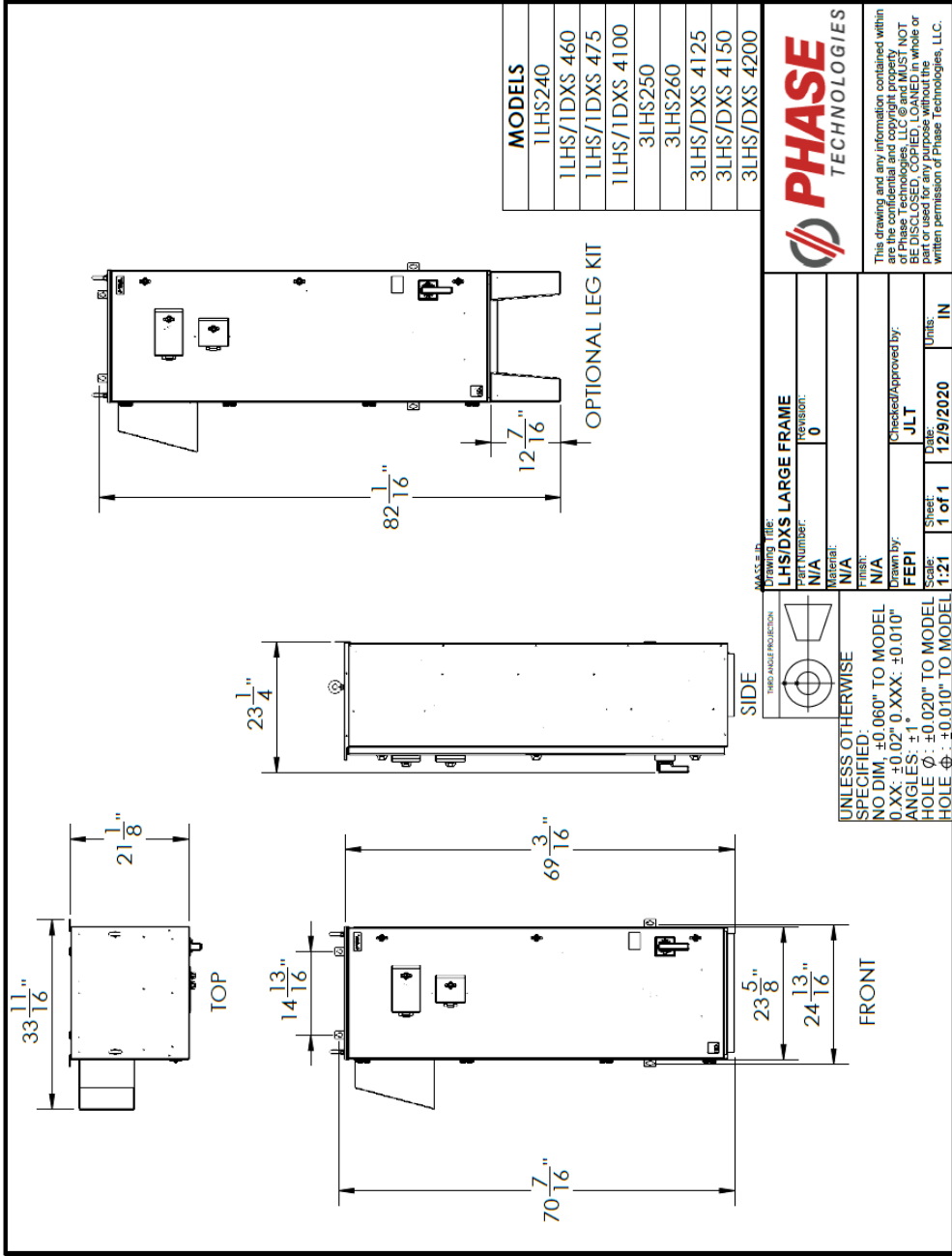

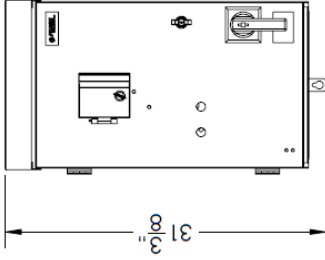
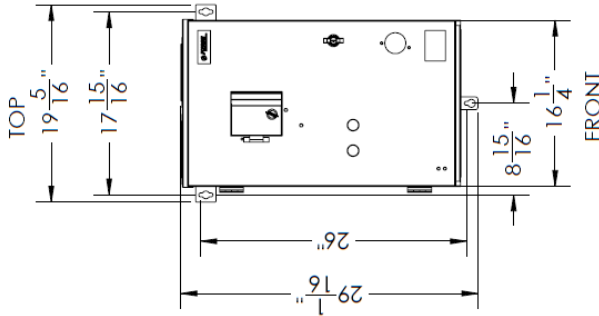
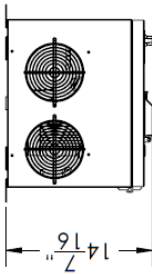

FRONT - 3R AND BREAKER

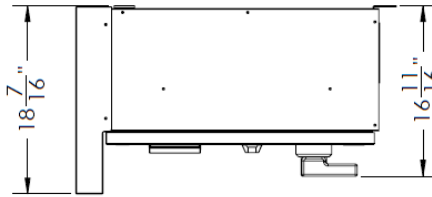

SIDE - 3R AND BREAKER

MODELS	
1LHE005	3LHE005
1LHE205	3LHE007
1LHE207	3LHE205
1LHE210	3LHE207
1LHE215	3LHE405
1LHE405	3LHE407
1LHE407	3LHE410
1LHE410	3LHE415
1LHE415	
1LHE420	
1LHE425	
1LHE430	
1LHE435	
1LHE440	
1LHE445	
1LHE450	
1LHE455	
1LHE460	
1LHE465	
1LHE470	
1LHE475	
1LHE480	
1LHE485	
1LHE490	
1LHE495	
1LHE500	
1LHE505	
1LHE510	
1LHE515	
1LHE520	
1LHE525	
1LHE530	
1LHE535	
1LHE540	
1LHE545	
1LHE550	
1LHE555	
1LHE560	
1LHE565	
1LHE570	
1LHE575	
1LHE580	
1LHE585	
1LHE590	
1LHE595	
1LHE600	
1LHE605	
1LHE610	
1LHE615	
1LHE620	
1LHE625	
1LHE630	
1LHE635	
1LHE640	
1LHE645	
1LHE650	
1LHE655	
1LHE660	
1LHE665	
1LHE670	
1LHE675	
1LHE680	
1LHE685	
1LHE690	
1LHE695	
1LHE700	
1LHE705	
1LHE710	
1LHE715	
1LHE720	
1LHE725	
1LHE730	
1LHE735	
1LHE740	
1LHE745	
1LHE750	
1LHE755	
1LHE760	
1LHE765	
1LHE770	
1LHE775	
1LHE780	
1LHE785	
1LHE790	
1LHE795	
1LHE800	
1LHE805	
1LHE810	
1LHE815	
1LHE820	
1LHE825	
1LHE830	
1LHE835	
1LHE840	
1LHE845	
1LHE850	
1LHE855	
1LHE860	
1LHE865	
1LHE870	
1LHE875	
1LHE880	
1LHE885	
1LHE890	
1LHE895	
1LHE900	
1LHE905	
1LHE910	
1LHE915	
1LHE920	
1LHE925	
1LHE930	
1LHE935	
1LHE940	
1LHE945	
1LHE950	
1LHE955	
1LHE960	
1LHE965	
1LHE970	
1LHE975	
1LHE980	
1LHE985	
1LHE990	
1LHE995	
1LHE1000	
1LHE1005	
1LHE1010	
1LHE1015	
1LHE1020	
1LHE1025	
1LHE1030	
1LHE1035	
1LHE1040	
1LHE1045	
1LHE1050	
1LHE1055	
1LHE1060	
1LHE1065	
1LHE1070	
1LHE1075	
1LHE1080	
1LHE1085	
1LHE1090	
1LHE1095	
1LHE1100	
1LHE1105	
1LHE1110	
1LHE1115	
1LHE1120	
1LHE1125	
1LHE1130	
1LHE1135	
1LHE1140	
1LHE1145	
1LHE1150	
1LHE1155	
1LHE1160	
1LHE1165	
1LHE1170	
1LHE1175	
1LHE1180	
1LHE1185	
1LHE1190	
1LHE1195	
1LHE1200	
1LHE1205	
1LHE1210	
1LHE1215	
1LHE1220	
1LHE1225	
1LHE1230	
1LHE1235	
1LHE1240	
1LHE1245	
1LHE1250	
1LHE1255	
1LHE1260	
1LHE1265	
1LHE1270	
1LHE1275	
1LHE1280	
1LHE1285	
1LHE1290	
1LHE1295	
1LHE1300	
1LHE1305	
1LHE1310	
1LHE1315	
1LHE1320	
1LHE1325	
1LHE1330	
1LHE1335	
1LHE1340	
1LHE1345	
1LHE1350	
1LHE1355	
1LHE1360	
1LHE1365	
1LHE1370	
1LHE1375	
1LHE1380	
1LHE1385	
1LHE1390	
1LHE1395	
1LHE1400	
1LHE1405	
1LHE1410	
1LHE1415	
1LHE1420	
1LHE1425	
1LHE1430	
1LHE1435	
1LHE1440	
1LHE1445	
1LHE1450	
1LHE1455	
1LHE1460	
1LHE1465	
1LHE1470	
1LHE1475	
1LHE1480	
1LHE1485	
1LHE1490	
1LHE1495	
1LHE1500	
1LHE1505	
1LHE1510	
1LHE1515	
1LHE1520	
1LHE1525	
1LHE1530	
1LHE1535	
1LHE1540	
1LHE1545	
1LHE1550	
1LHE1555	
1LHE1560	
1LHE1565	
1LHE1570	
1LHE1575	
1LHE1580	
1LHE1585	
1LHE1590	
1LHE1595	
1LHE1600	
1LHE1605	
1LHE1610	
1LHE1615	
1LHE1620	
1LHE1625	
1LHE1630	
1LHE1635	
1LHE1640	
1LHE1645	
1LHE1650	
1LHE1655	
1LHE1660	
1LHE1665	
1LHE1670	
1LHE1675	
1LHE1680	
1LHE1685	
1LHE1690	
1LHE1695	
1LHE1700	
1LHE1705	
1LHE1710	
1LHE1715	
1LHE1720	
1LHE1725	
1LHE1730	
1LHE1735	
1LHE1740	
1LHE1745	
1LHE1750	
1LHE1755	
1LHE1760	
1LHE1765	
1LHE1770	
1LHE1775	
1LHE1780	
1LHE1785	
1LHE1790	
1LHE1795	
1LHE1800	
1LHE1805	
1LHE1810	
1LHE1815	
1LHE1820	
1LHE1825	
1LHE1830	
1LHE1835	
1LHE1840	
1LHE1845	
1LHE1850	
1LHE1855	
1LHE1860	
1LHE1865	
1LHE1870	
1LHE1875	
1LHE1880	
1LHE1885	
1LHE1890	
1LHE1895	
1LHE1900	
1LHE1905	
1LHE1910	
1LHE1915	
1LHE1920	
1LHE1925	
1LHE1930	
1LHE1935	
1LHE1940	
1LHE1945	
1LHE1950	
1LHE1955	
1LHE1960	
1LHE1965	
1LHE1970	
1LHE1975	
1LHE1980	
1LHE1985	
1LHE1990	
1LHE1995	
1LHE2000	
1LHE2005	
1LHE2010	
1LHE2015	
1LHE2020	
1LHE2025	
1LHE2030	
1LHE2035	
1LHE2040	
1LHE2045	
1LHE2050	
1LHE2055	
1LHE2060	
1LHE2065	
1LHE2070	
1LHE2075	
1LHE2080	
1LHE2085	
1LHE2090	
1LHE2095	
1LHE2100	
1LHE2105	
1LHE2110	
1LHE2115	
1LHE2120	
1LHE2125	
1LHE2130	
1LHE2135	
1LHE2140	
1LHE2145	
1LHE2150	
1LHE2155	
1LHE2160	
1LHE2165	
1LHE2170	
1LHE2175	
1LHE2180	
1LHE2185	
1LHE2190	
1LHE2195	
1LHE2200	
1LHE2205	
1LHE2210	
1LHE2215	
1LHE2220	
1LHE2225	
1LHE2230	
1LHE2235	
1LHE2240	
1LHE2245	
1LHE2250	
1LHE2255	
1LHE2260	
1LHE2265	
1LHE2270	
1LHE2275	
1LHE2280	
1LHE2285	
1LHE2290	
1LHE2295	
1LHE2300	
1LHE2305	
1LHE2310	
1LHE2315	
1LHE2320	
1LHE2325	
1LHE2330	
1LHE2335	
1LHE2340	
1LHE2345	
1LHE2350	
1LHE2355	
1LHE2360	
1LHE2365	
1LHE2370	
1LHE2375	
1LHE2380	
1LHE2385	
1LHE2390	
1LHE2395	
1LHE2400	
1LHE2405	
1LHE2410	
1LHE2415	
1LHE2420	
1LHE2425	
1LHE2430	
1LHE2435	
1LHE2440	
1LHE2445	
1LHE2450	
1LHE2455	
1LHE2460	
1LHE2465	
1LHE2470	
1LHE2475	
1LHE2480	
1LHE2485	
1LHE2490	
1LHE2495	
1LHE2500	
1LHE2505	
1LHE2510	
1LHE2515	
1LHE2520	
1LHE2525	
1LHE2530	
1LHE2535	
1LHE2540	
1LHE2545	
1LHE2550	
1LHE2555	
1LHE2560	
1LHE2565	
1LHE2570	
1LHE2575	
1LHE2580	
1LHE2585	
1LHE2590	
1LHE2595	
1LHE2600	
1LHE2605	
1LHE2610	
1LHE2615	
1LHE2620	
1LHE2625	
1LHE2630	
1LHE2635	
1LHE2640	
1LHE2645	
1LHE2650	
1LHE2655	
1LHE2660	
1LHE2665	
1LHE2670	
1LHE2675	
1LHE2680	
1LHE2685	
1LHE2690	
1LHE2695	
1LHE2700	
1LHE2705	
1LHE2710	
1LHE2715	
1LHE2720	
1LHE2725	
1LHE2730	
1LHE2735	
1LHE2740	
1LHE2745	
1LHE2750	
1LHE2755	
1LHE2760	
1LHE2	

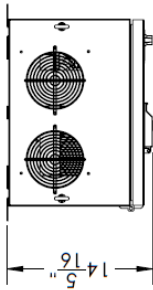

TOP

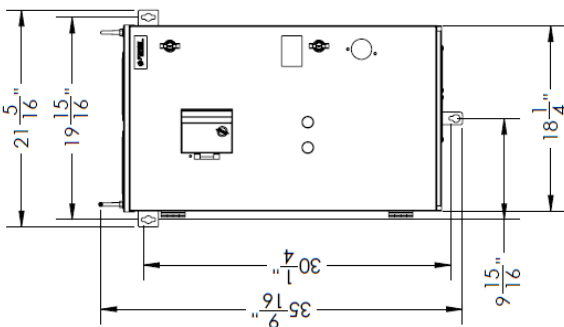

FRONT

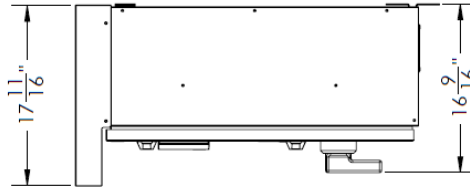

SIDE - 3R AND BREAKER

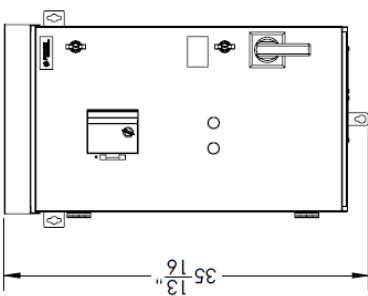

FRONT - 3R AND BREAKER

MODELS			
1LHE007	DXE010	SDE410	
1LHE010	DXE015	SDE415	
1LHE015	DXE020		
1LHE020	DXE025		
1LHE220	DXE030		
1LHE225	DXE210		
1LHE415	DXE425		
1LHE420	DXE430		
1LHE425	DXE440		
1LHE430	DXE415		
	DXE420		
	DXE425		
	DXE430		
	DXE440		
	DXE450		

THIRD ANGLE PROJECTION

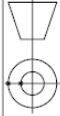

UNLESS OTHERWISE

SPECIFIED:
 NO DIM: ±0.060" TO MODEL
 0.XX: ±0.02" 0.XXX: ±0.010"
 ANGLES: ±1°
 HOLE Ø: ±0.020" TO MODEL
 HOLE Ø: ±0.010" TO MODEL

DRAWING TITLE: Enterprise Large
Part Number: See Model Table
Material: N/A
Finish:

Revision: 5

Drawn by: AHK
Scale: 1 of 1
Date: 2/3/2021
Units: IN

Checked/Approved by:



This drawing and any information contained within it is the property of Phase Technologies, LLC and MUST NOT BE DISCLOSED, COPIED, LOANED in whole or part or used for any purpose without the written permission of Phase Technologies, LLC.

LIMITED WARRANTY



Phase Technologies' 1LH, 3LH, DX, and SDE Series drives are warranted against defects in material and workmanship for a period of two years. This warranty covers both parts and labor (at Phase Technologies) for two years from the date of purchase by the original owner. Phase Technologies will repair or replace (at our option), at no charge, any part(s) found to be faulty during the warranty period specified. The warranty repairs must be performed by/at a Phase Technologies Authorized Service Center or at Phase Technologies LLC, Rapid City, SD.

Obligations of the Original Owner

1. The original Bill of Sale must be presented to obtain "in-warranty" service.
2. Transportation to Phase Technologies or an Authorized Service Center is the responsibility of the original purchaser. Return transportation is provided by Phase Technologies.
3. Installations must comply with all national and local electrical codes.

Exclusions of the Warranty

This warranty does not cover any of the following: accident, misuse, fire, flood, and other acts of God, nor any contingencies beyond the control of Phase Technologies, LLC, including water damage, incorrect line voltage, improper installation, missing or altered serial numbers, and service performed by an unauthorized facility. Phase Technologies' liability for any damages caused in association with the use of Phase Technologies' equipment shall be limited to the repair or replacement only of the Phase Technologies' equipment. No person, agent, distributor, dealer, or company is authorized to modify, alter, or change the design of this merchandise without express written approval of Phase Technologies, LLC.

INSTALLATIONS MUST COMPLY WITH ALL NATIONAL AND LOCAL ELECTRICAL CODE REQUIREMENTS.



Scan to download



NEW ADDRESS

222 Disk Drive, Rapid City, SD 57701
605-343-7934 - Main 866-250-7934 - Toll Free

www.phasetechnologies.com

PHASE

